

At Atkore
We Secure Your Vision

New Product Showcase



Atkore[™]
Razor Ribbon

Introduction	3
Ultra Maximum Coils.....	4
Flat Razor Wrap Topper Double Coil.....	5
Minimum to Ultra Maximum Security Applications.....	6
Barbless Tape.....	8
NATO-22 Barbed Tape.....	9
NATO-22 Razor Strand™ Topper	10
Razor Spike Topper	11
Razor Mesh Panels	12
Razor Mesh Panel Topper.....	14
Razor Cage.....	15
Instabox Portable Rapid Deployment Unit.....	16
Rapid Deployment Unit Trailers.....	17
Safety Security Solutions Bollards	18

Introduction

New Product Showcase

Razor-Ribbon® is a leading manufacturer of barbed tape products and a domestic manufacturer in the United States.

The Razor-Ribbon line of barbed tape products is the optimal choice for perimeter security protection. Manufactured for use in the most secure and restricted environments, Razor-Ribbon has enhanced security

protection for a variety of industrial, military, and institutional facilities.

Our Razor-Ribbon products are razor sharp and can create serious cuts on anyone trying to climb over the barrier. The products are not only used as a physical barrier but also work as a psychological deterrent. Razor-Ribbon is designed to deter, delay, and detect intruders.

What Sets Us Apart

- Nationwide and international distribution
- Superior deterrence and security
- Manufactured from exceptionally tough, high-quality stainless steel components with full traceability
- Single or double coil spiral or concertina available
- Various diameter and deployed lengths available
- Large capacity with quick turnaround
- Product workmanship warranty
- Easy-to-install
- Unparalleled customer and technical support

Barbed Tape Styles

Short Barb



Medium Barb



BTC NATO Barb



Long Barb



Instabarrier® Barb



Detainer Hook® Barb



Ultra Maximum Coils

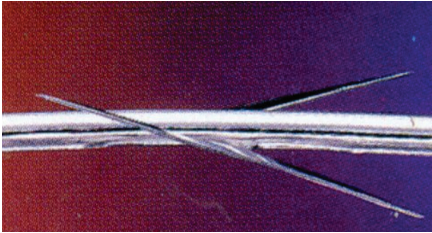

Offset Barb

Features

- Exclusive to Razor-Ribbon products
- Most specified product in US government applications
- Offset barbs greatly increase the coil density and the psychological deterrence
- Barb effectiveness is much greater due to an increased opportunity for barb penetration
- Delay times are increased with the offset barb
- Available on Medium, NATO-22 and Long barb products

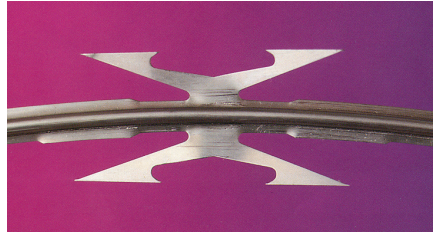

Detainer Hook®

Features

- Ultra-high perimeter security applications
- Single coil wire-reinforced concertina
- Barb designed with clusters of 8 needle sharp barbs along the spiral turns
- Barb angle and hooked barb configuration is the most severe Razor-Ribbon product produced
- Concertina barbed tape and core available in galvanized or stainless steel
- Various standard diameter and coil lengths available, custom sizes available upon request
- Made in USA. Complies with Buy America Act



Instabarrier®

Features

- Ideal for maximum security ground barrier applications
- The most versatile of all barbed tape products
- Deploys tangle free for fast installation for both temporary and permanent use
- Permits rapid recovery and reuse, goes back into original shape
- Punched with offset barbs for greater entanglement and psychological deterrence
- Single coil stainless steel non-reinforced concertina diameters of 24", 30", 40", 60" (600mm, 750mm, 1000mm, 1500mm)
- Made in USA. Complies with Buy America Act

Flat Razor Wrap Topper Double Coil

Features

- Psychological deterrence
- Aesthetically pleasing
- Perimeter security delay barrier
- Easily replaceable in case of damage
- Multiple rows of Flat Razor Wrap can be added
- Aesthetically pleasing powder coat finish available for added corrosion protection
- Made in USA. Complies with Buy America Act
- Flat Razor Wrap - 18" to 24" diameter
- Post - Height varies based on diameter used

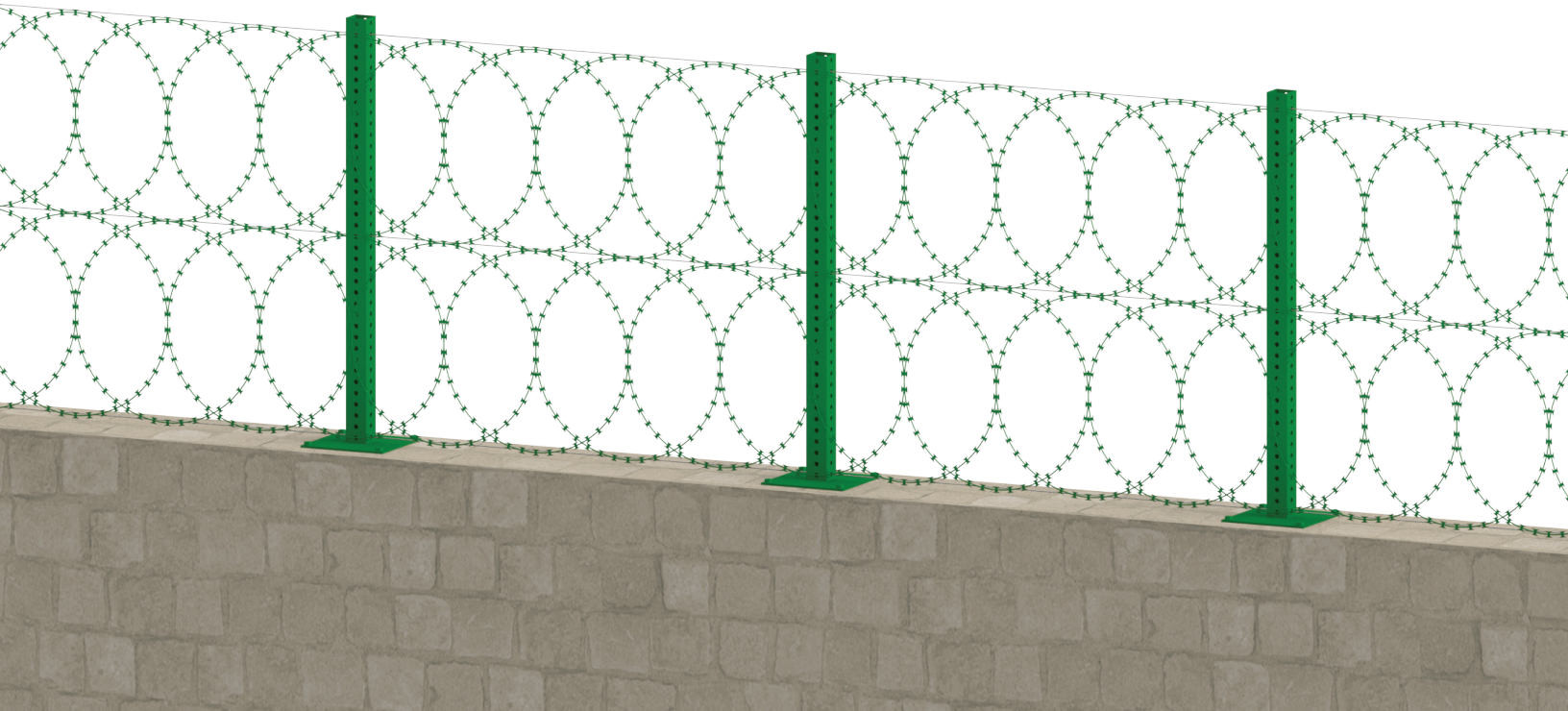
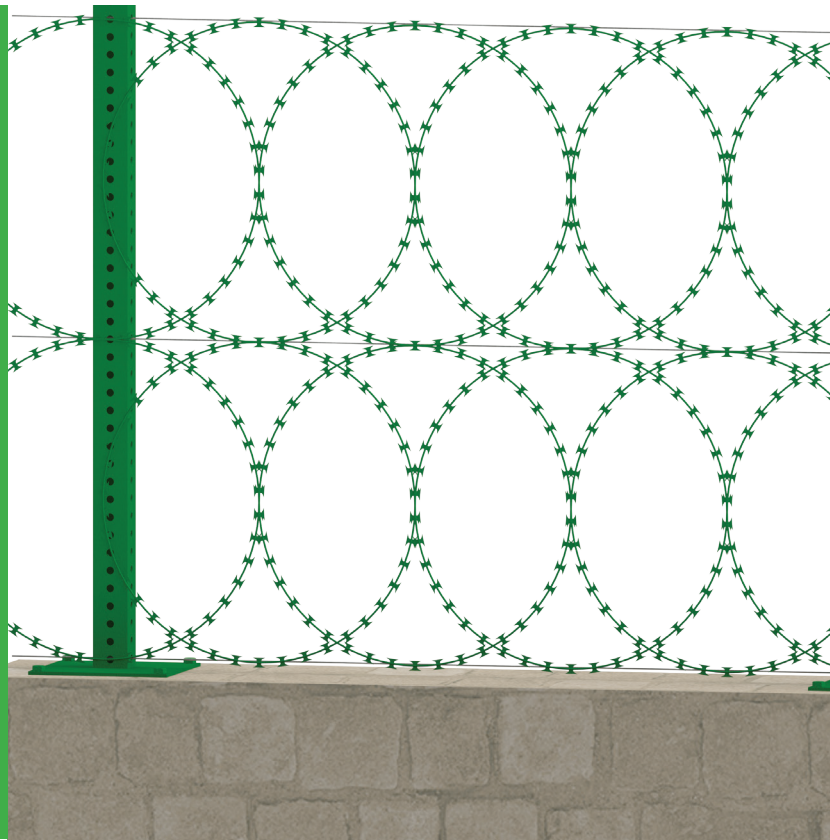

Minimum to Ultra Maximum Security Applications

Helical

For industrial and private low level security applications



InstabARRIER®

Designed for temporary and permanent use, this is the most versatile maximum security ground barrier for confinement applications.

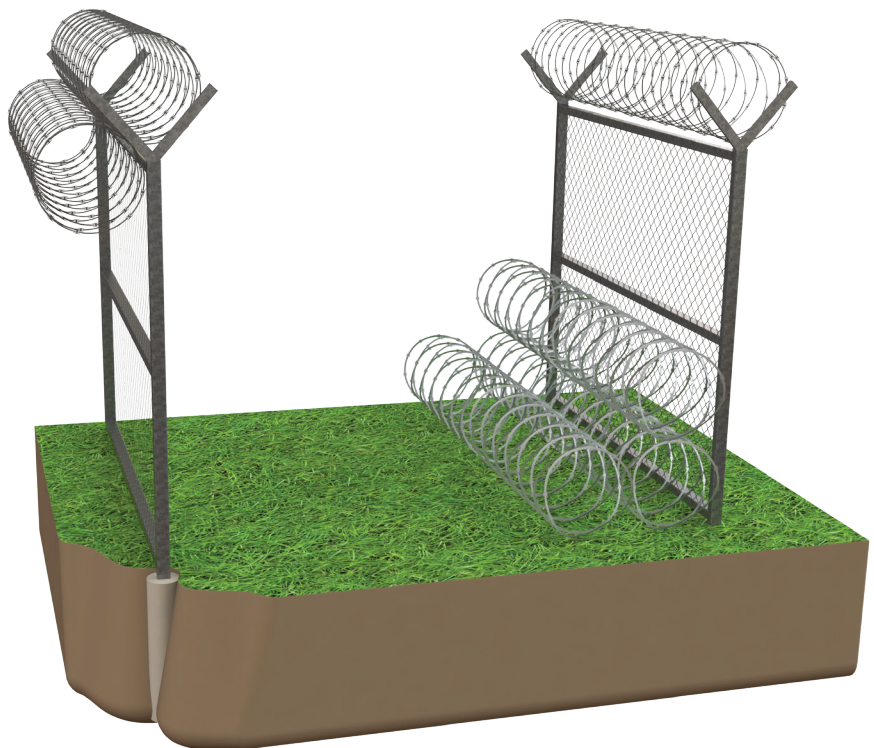

Minimum to Ultra Maximum Security Applications

Supermaze®

For high density maximum security applications

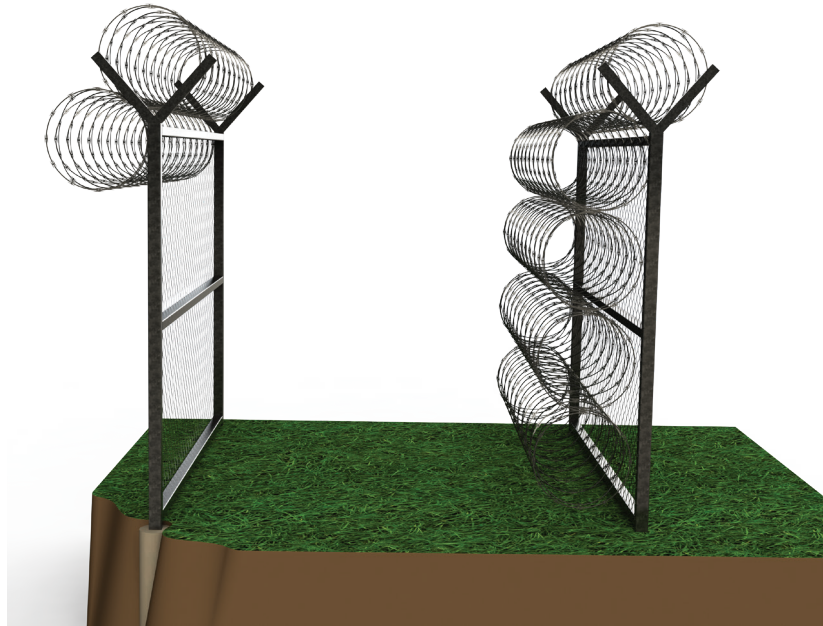

Barbed Tape Concertina (BTC)

Single coil wire-reinforced concertina for military battlefield and training barrier applications.

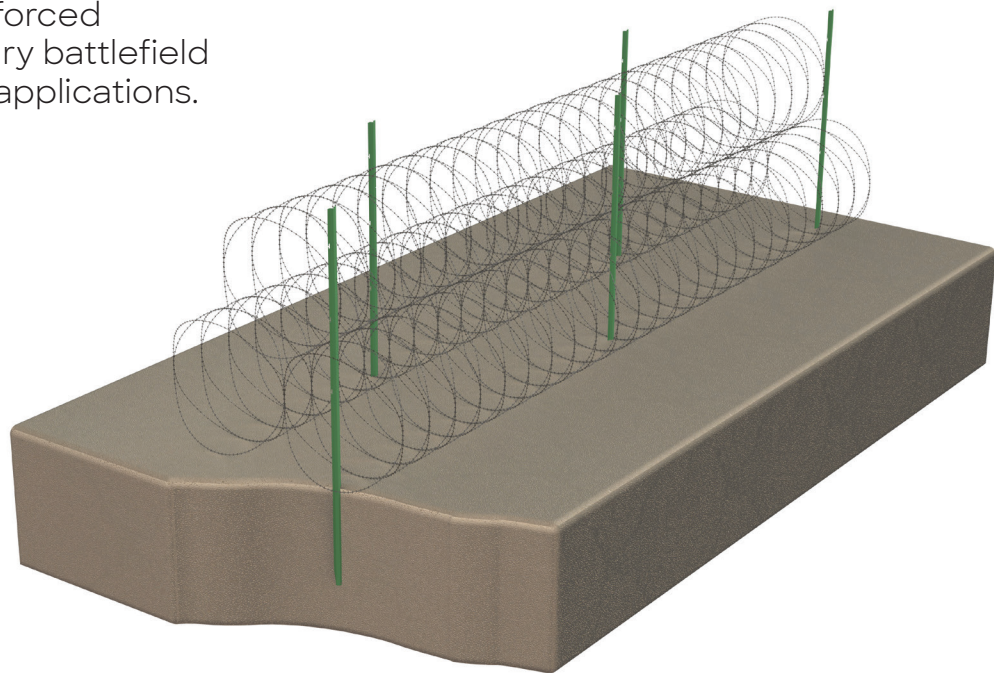

Features

- Rigid – Reinforced concertina coil manufactured from galvanized or stainless steel material
- Delay Barrier – Physical barrier that deters intrusion
- Entanglement – Entangles intruders when they try to surpass the barrier
- Protective – Ideal solution for low level security applications
- Harmless – Smooth profile means no cuts and no harm, even when touched with bare hands
- Safe – Powder coated yellow for caution, can be deployed and retrieved without the use of personal protective equipment
- Made in USA. Complies with Buy America Act

Helical

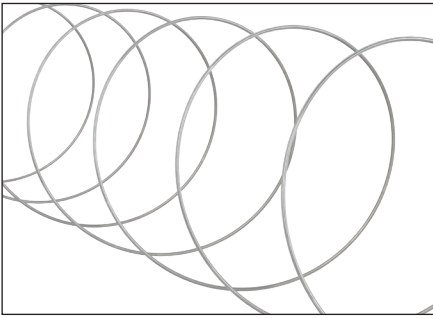

Panel w/ Flat Barbless Wrap



Flat Barbless Wrap

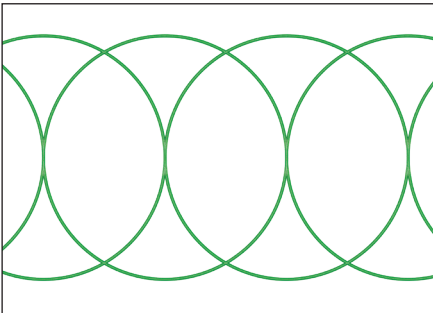

Instabox Portable RDU

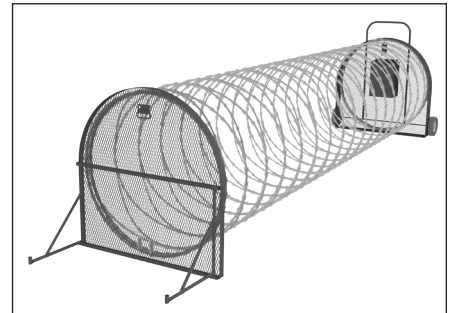

Barbless Concertina

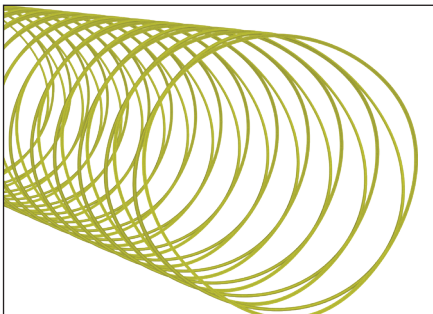

Rapid Deployment Unit (RDU)

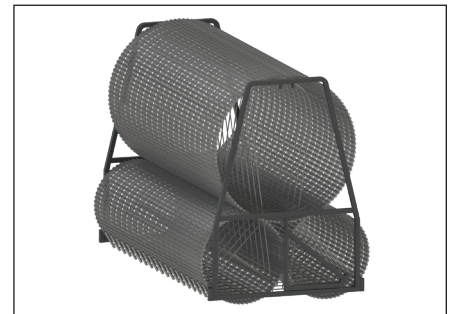

NATO-22 Barbed Tape



Razor Strand™

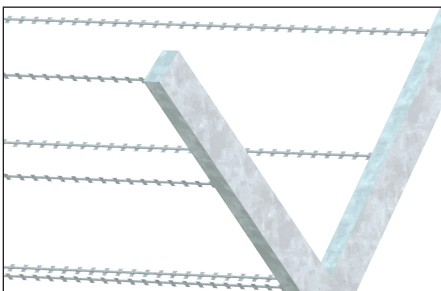

Coreless

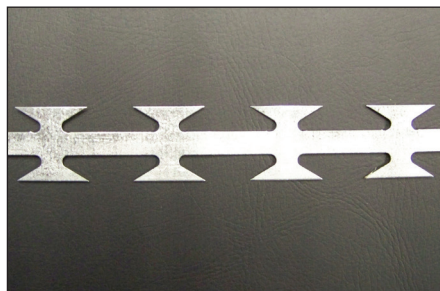

Helical



Concertina



Flat Razor Wrap



Rapid Deployment



Features

- Developed for applications requiring NATO compliance as it is the most specified in the UK and European countries
- Exceptional Quality - Like all Razor-Ribbon products, NATO-22 is manufactured out of high-quality/high-strength stainless or galvanized steel meeting all European standards and specifications
- Countless Configurations - NATO-22 barbed tape comes in more standard diameter/loops/clips configurations than any other Razor-Ribbon product
- Versatile - The NATO-22 barb is available on all Razor-Ribbon products
- Available powder coated color
- Made in USA. Complies with Buy America Act

NATO-22 Razor Strand[™] Topper

Features

- Anti-climb barrier
- Deterrent and delay wire solution
- Aesthetically pleasing powder coat finish available for added corrosion protection
- Made in USA. Complies with Buy America Act
- Razor Strand - NATO-22 barb shown (available in any barb type)
- Y-Arm - Barb arms welded to base, can be configured with 3 strand or 5 strand

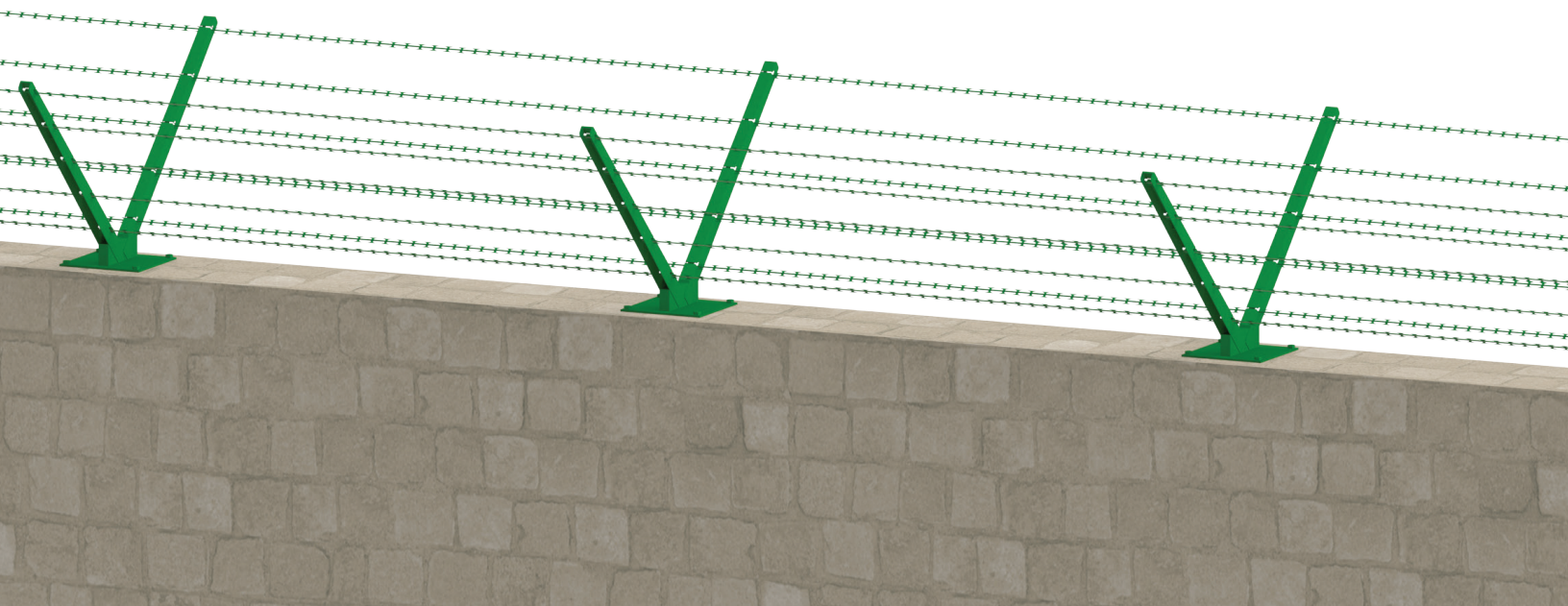
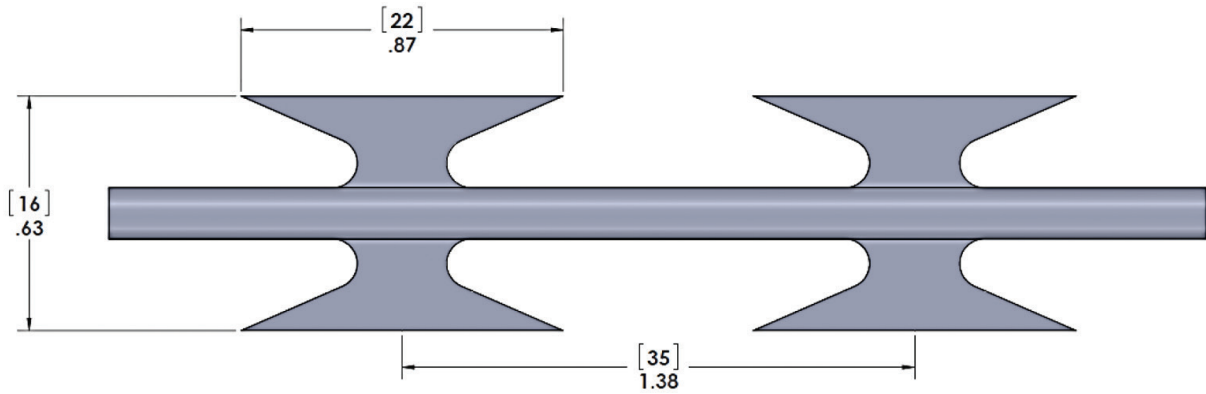
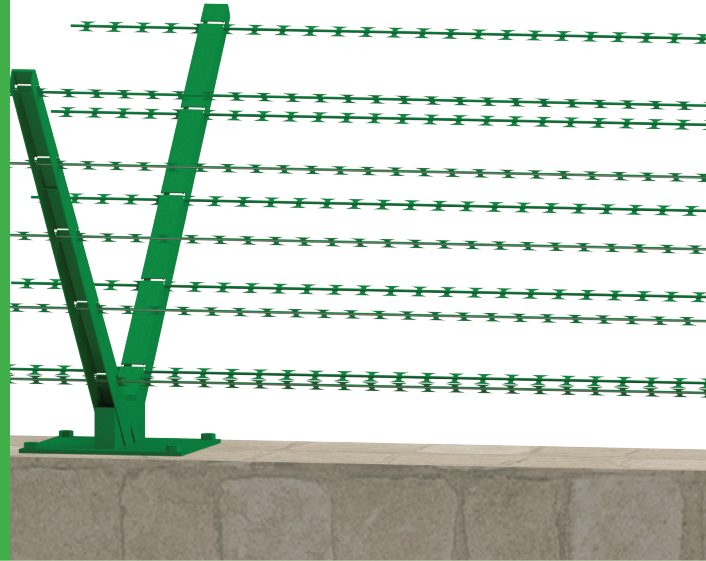

Razor Spike Topper

Features

- Manufactured from 22 gauge high strength steel
- 2-½" tall spikes
- 4ft long Razor Spike sections
- Mounting holes provided for easy attachment
- Can be mounted on top or front surface
- Aesthetically pleasing powder coat finish available for added corrosion protection
- Made in USA. Complies with Buy America Act

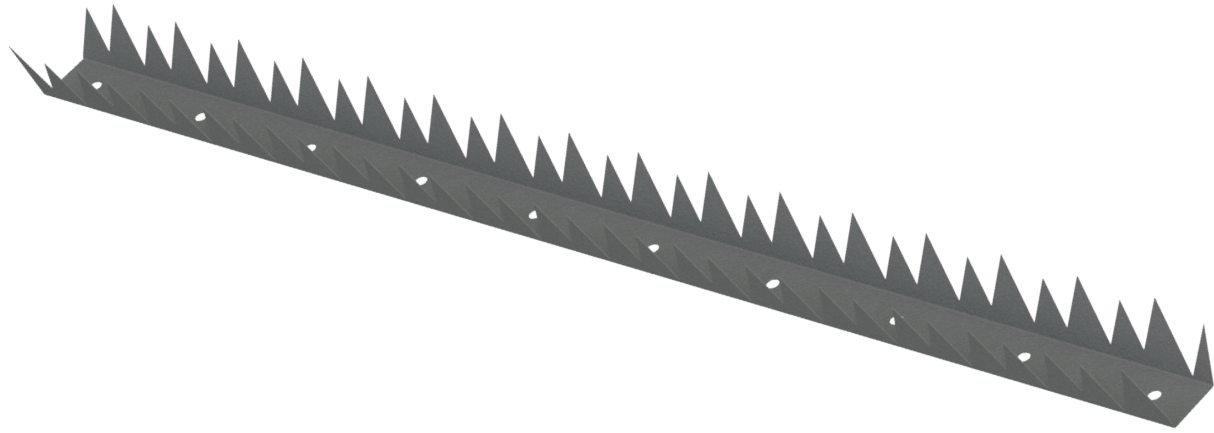
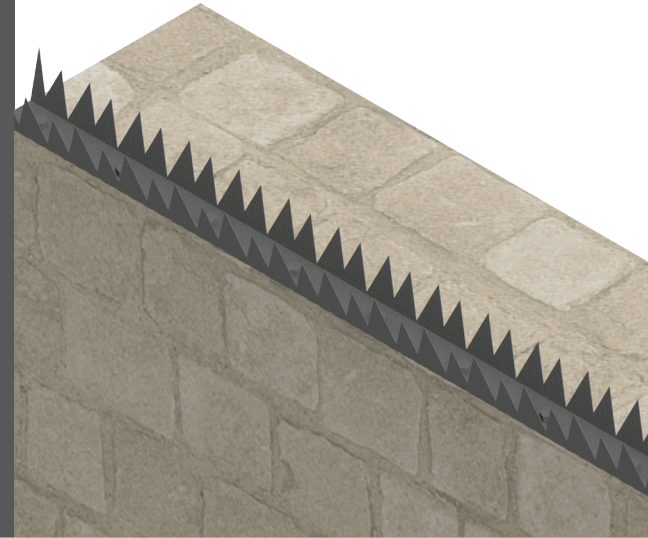

Features

- FIRST line of defense to secure a perimeter
- DETER – Unmatched, imposing physical and psychological deterrent
- DELAY – Anti-cut / Anti-climb properties make it difficult to surpass
- PROTECT – Physical barrier designed to deter and delay attacks keeping your assets protected
- Panels can be installed as standalone or easily integrated with any existing fence framework
- Can be mounted horizontally or vertically
- Made in USA. Complies with Buy America Act

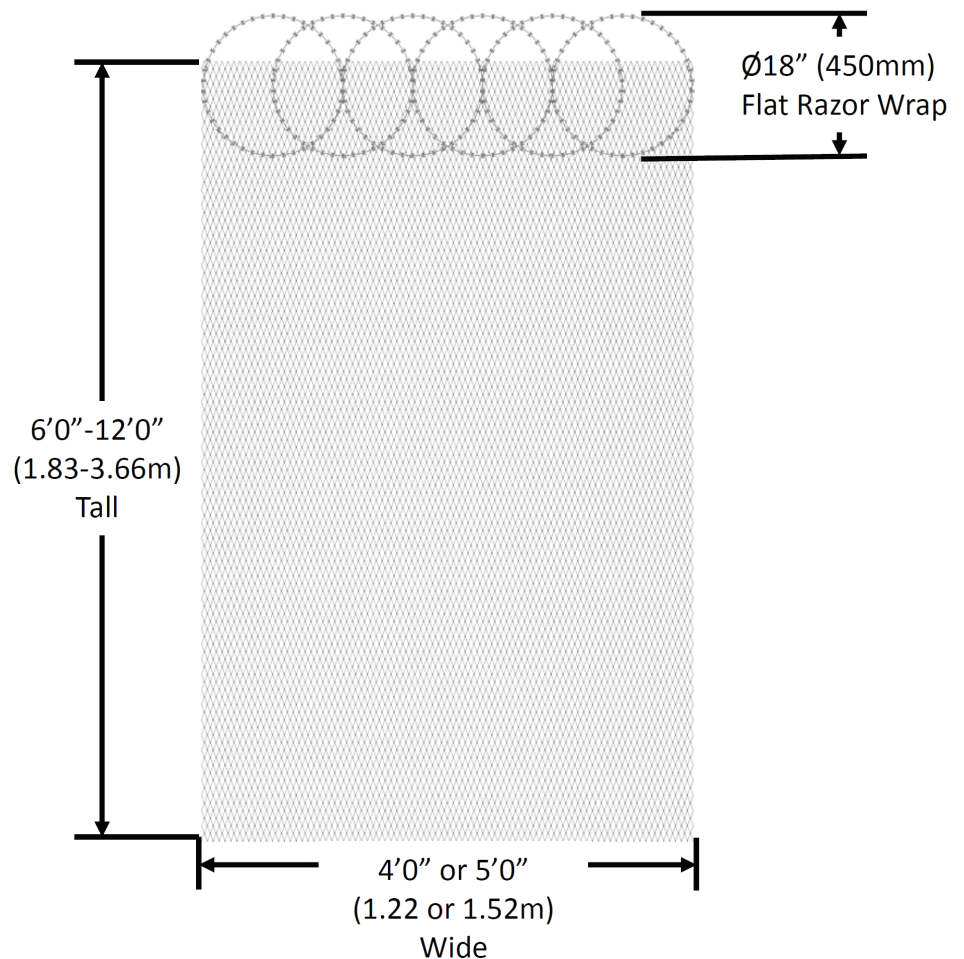
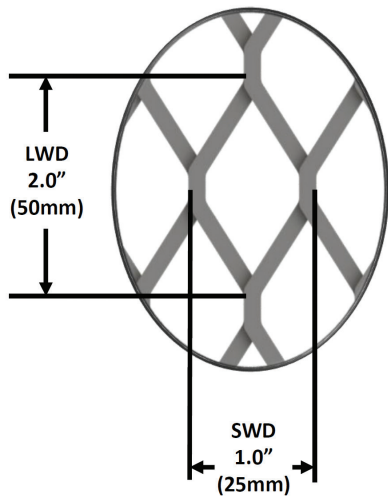

Razor Mesh Panels

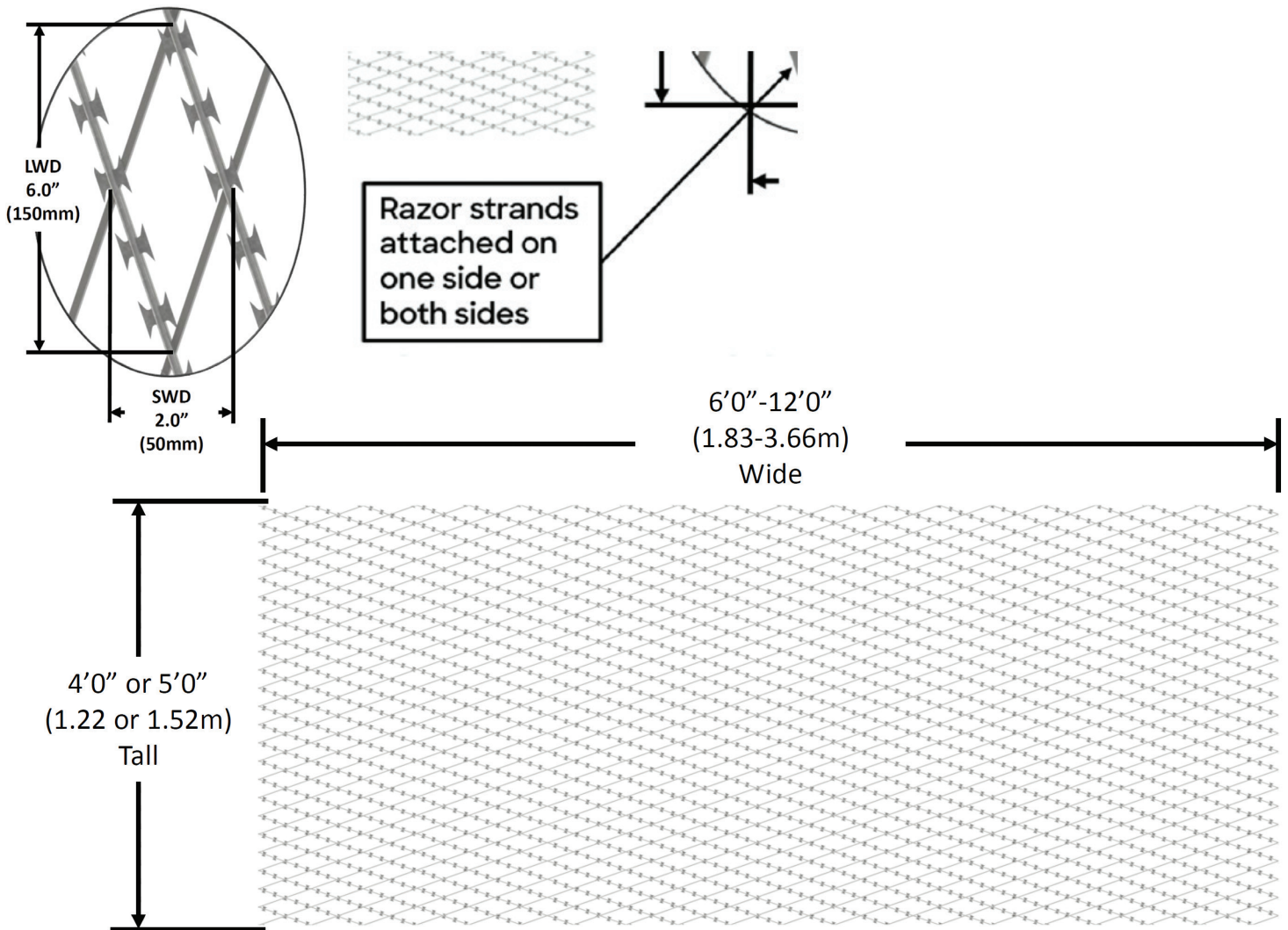

Features

- FIRST line of defense to secure a perimeter
- DETER – Unmatched, imposing physical and psychological deterrent
- DELAY – Anti-cut / Anti-climb properties make it difficult to surpass
- PROTECT – Physical barrier designed to deter and delay attacks keeping your assets protected
- Aesthetically pleasing powder coat finish available for added corrosion protection
- Made in USA. Complies with Buy America Act
- Panel Size – 3' to 5' H x 5' W

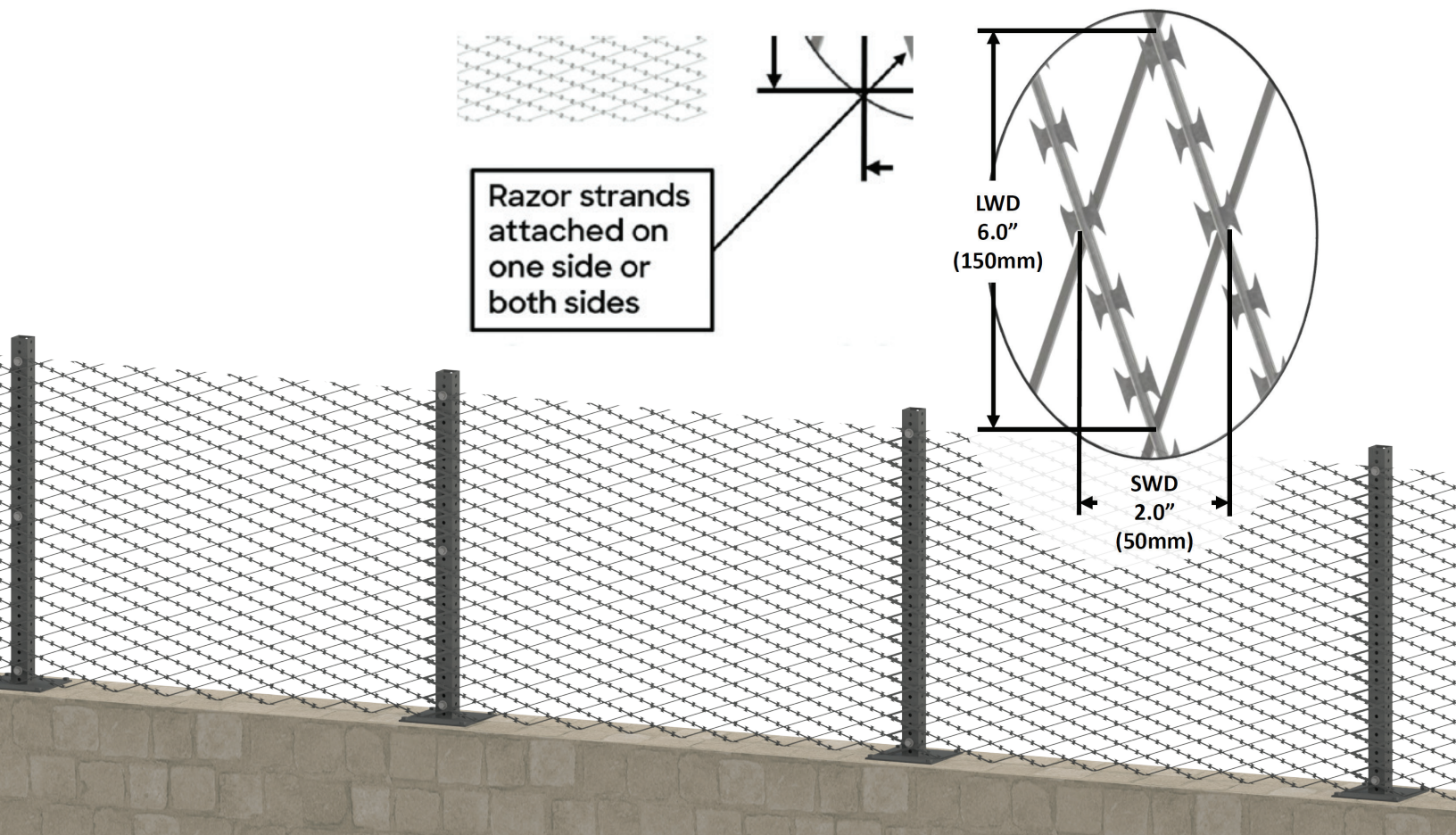
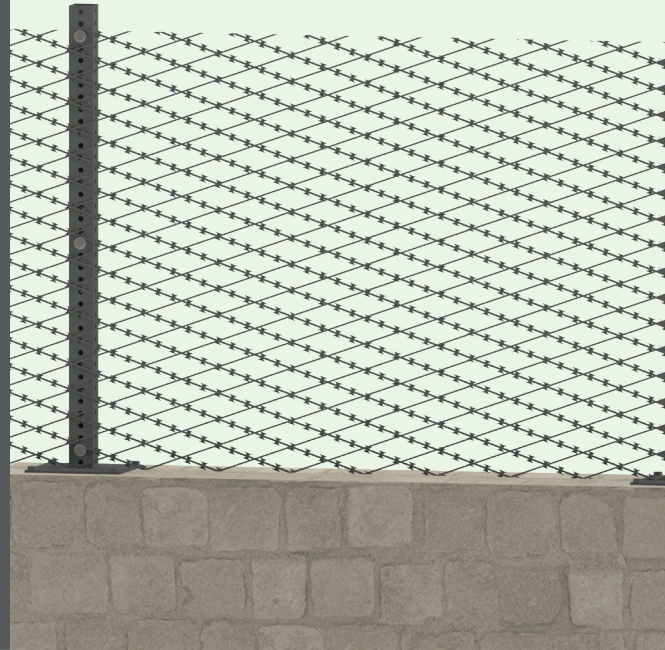

Razor Cage

Razor Cage with swinging door for asset storage

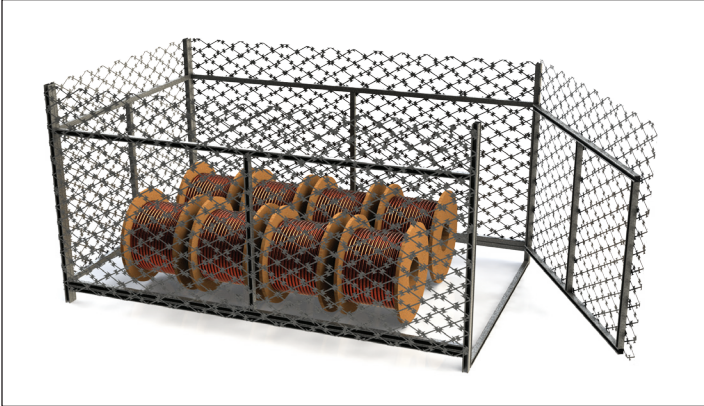

Razor Cage with fold down door for asset storage

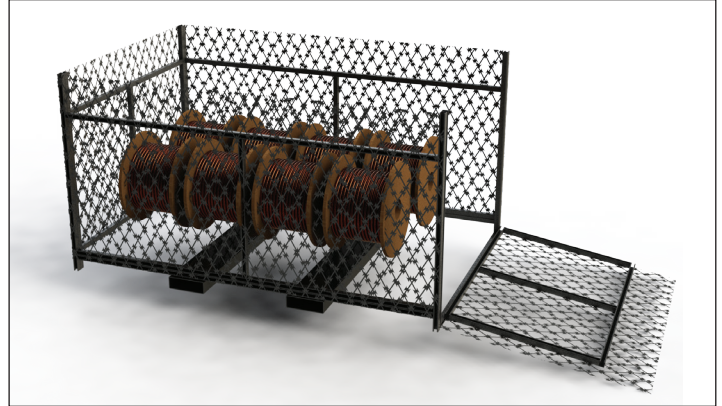

Razor Cage perimeter around assets

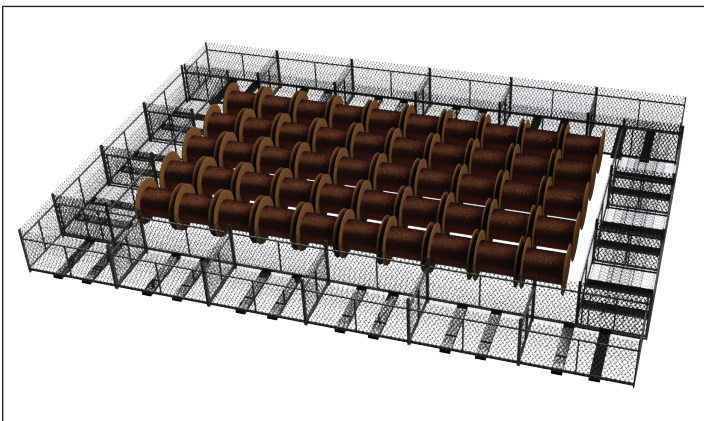

Razor Cage with Triple Strand Rapid Deployment Unit for gate and expanded barrier protection



Features

- Patent pending design protects a perimeter or an open space and restricts unauthorized vehicle access
- Available in hot-dip galvanized or stainless steel
- Easily moved and installed with a forklift
- Cage dimensions - 16' (4.9m) L x 6' (1.8m) W x 6' (1.8m) H (customizable)
- Specified as a permanent or temporary barrier
- Custom designed based on your security needs
- Ideal for utility or power plant applications
- Made in USA. Complies with Buy America Act

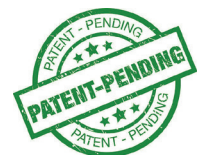

Instabox Portable Rapid Deployment Unit

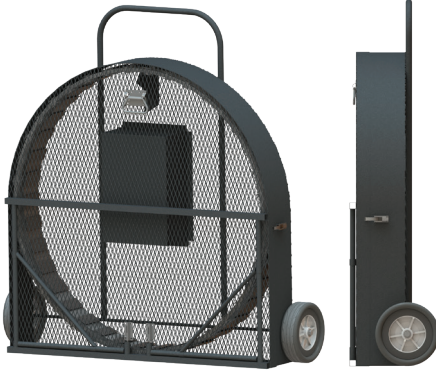

Features

- Patent pending design provides rapid barrier for controlled, limited and exclusion areas
- Appropriate as a temporary or permanent barrier for emerging threats
- Deploys up to 75 feet (22.8m) of barbless tape or non-reinforced Instabarrier® barbed tape in under 30 seconds
- Deploys and retracts quickly and efficiently for reuse by a single person
- Removes the potentially hazardous conditions associated with field installation of coils
- Rugged design features heavy duty wheels, hot-dip galvanized panels and powder coat finish make the unit suitable for deployment in differing climates and terrain
- Lightweight, high strength and modular allowing multiple units to be easily tied together forming one continuous barrier
- Made in USA. Complies with Buy America Act

Instabox with Barbless Coil

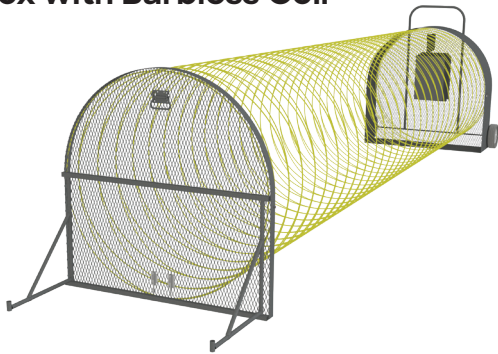

Instabox with Instabarrier® Coil

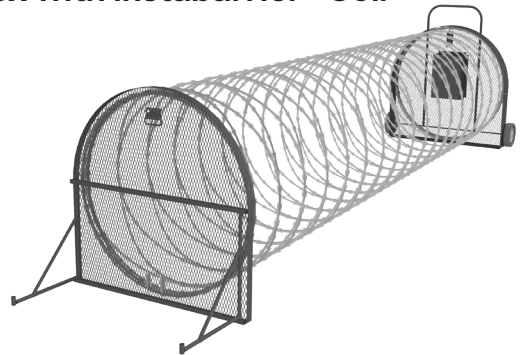

Catalog Number	Diameter		Coil Loops	Strip Material	Cable	Welds	Yield		Pkg.
	(in)	(mm)					(in)	(mm)	
Single Coil Concertina Rapid Deployment	30	762	101	SS	1	5	50	15.2	1
Single Coil Concertina Rapid Deployment	30	762	151	SS	1	5	75	22.8	1
Single Coil Concertina Rapid Deployment	48	1219	151	SS	1	9	75	22.8	1
Single Coil Concertina Rapid Deployment	60	1524	101	SS	1	13	50	15.2	1

BTC Express Trailer (Patented)

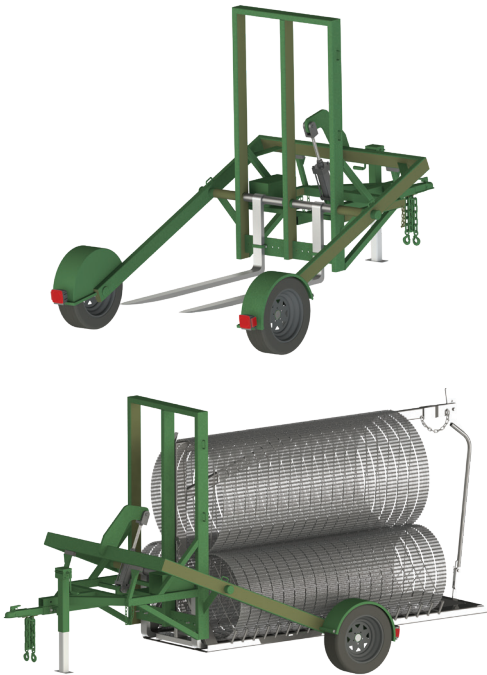

Features

- Versatile and economical rapid deployment system
- Designed for use in difficult terrains where forklifts can't be used to deploy a Triple-Strand Rapid Deployment Unit
- Compatible with any vehicle equipped with a standard hitch
- Trailer dimensions - 12.5' (3.8m) L x 7.3' (2.2m) W x 7' (2.1m) H approx.
- Trailer features - 4,000lb (1800kg) capacity, 6' (1.8m) long forks (fixed or adjustable), 5' (1.5m) width capacity, Hydraulic controls, Powder coat finish (customizable)
- Razor barrier dimensions - 500' (150m) L x 4.6' (1.4m) W x 6' (1.8m) H
- Triple-Strand Razor Wire Barrier (customizable)
- Made in USA. Complies with Buy America Act

Rapid Deployment Unit (RDU) Trailer RDU (Patented)

Features

- 3-pack RDU barrier housed in a covered trailer capable of deploying up to 500' (150m) in 30 seconds
- Reusable barrier - Coils can be loaded back onto the trailer and ready for redeployment in under 10 minutes
- RDU can be deployed as a temporary or permanent barrier for emerging threats
- Available in various lengths, barb styles, and configurations in stainless steel or galvanized steel
- RDU can be custom designed to fit customer's security needs
- Approved and used by the U.S. Department of Defense and other government agencies
- Made in USA. Complies with Buy America Act

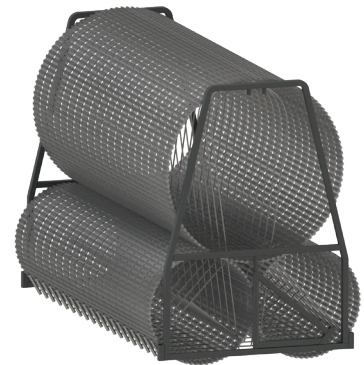

Bollard Types

Lighted

Architectural Lighted Bollards provide an aesthetic appeal while illuminating the surrounding landscape within a secure perimeter. Anchored to a baseplate foundation, these bollards are easy to install in any location.

- Stainless steel
- Light duty security lighted bollards
- Medium/Heavy security lighted bollards



Fixed

Permanently embedded bollards create a physical barrier for pedestrians and buildings from oncoming vehicles.

- Light security – parking lots, entrances, retail storefronts
- Medium security – hospitals, malls, stadiums
- High security – government facilities, power plants, chemical plants



Removable

External padlocking removable bollards provide a removable perimeter defense. Allows easy access for service and police vehicles into restricted areas.

- Type 316 stainless steel versions for harsher environments
- Parking lots, fire lanes, access roads, and driveways,
- Colleges, oil refineries, municipalities



Safety Security Solutions Bollards

Bollard Types

Automatic Retractable

Designed for repetitive cycles, these bollards are ideal for high-level traffic control parking lots, access control gates, commercial building entrances, and military bases. These bollards can

- Stainless steel composition to avoid corrosion
- Operate with most existing access control systems
- Key system, guard operated, proximity card



Shallow Mount

These bollards use a shallow 12" embedment to provide the highest level of protection found around corporate campuses, government buildings, airports, power and water plants.

- Can stop a 15,000-pound vehicle at a speed of 50 miles per hour
- K12/M50-rated
- Significant savings over deep mount bollard installations



Crash Rated

ASTM F3016 crash-rated bollards protect people and property that are vulnerable to low-speed vehicular impact.

- K4/M30- and K12/M50-rated options
- Fixed and removable versions
- Airports, manufacturing plants, railways, gas stations, transportation terminals





Allied Tube & Conduit ^ AFC Cable Systems ^ Heritage Plastics ^ Unistrut
Unistrut Construction ^ Cope ^ US Tray ^ Calbrite ^ Calbond ^ Kaf-Tech
Columbia-MBF ^ Eastern Wire + Conduit ^ ACS/Uni-Fab ^ Cii
Power-Strut ^ Calconduit ^ Razor Ribbon ^ Calpipe Security
FRE Composites ^ Vergokan ^ Flexicon ^ Marco

Atkore
250 Capital Drive
Hebron, OH 43025

877-285-4066

atkore.com/razorribbon

Want to join a company that helps you build
the mindset, skill set and tool set for success?
Visit us at atkore.com/careers