



SECURITY SOLUTIONS

Energy, Utility and Municipal Markets



Atkore[™]
Razor Ribbon

Perimeter security solutions for the Energy, Utility and Municipal Markets

Customers throughout the United States are reporting increasing issues with break-ins, vandalism, theft and loitering at their sites and have reached out to Atkore Razor-Ribbon® for solutions to prevent such intrusions. Atkore Razor-Ribbon has worked with several energy power plants, utilities and municipal customers providing different perimeter security solutions that deter, delay and protect based on each customers' specific needs.

Atkore Razor-Ribbon's Razor Mesh Panel solutions can be adapted to meet any level of security. Razor Mesh Panels come in a variety of styles that include the combination of expanded metal panels being integrated with Razor Strands or Flat Razor Wrap. Each solution is designed based on the voice of the customer to make sure all of their security needs are met.

Shown below is an example of just one solution that was developed to increase the security of a perimeter fence. The Razor Mesh Panels were installed as a retro-fit over the existing chain link fence which instantly increased the height of the fence, made the fence significantly more difficult to cut or climb, and created an imposing physical and psychological deterrent. The customer that was once experiencing several break-ins and thefts per month has reported zero intrusions since the installation of the panels several years prior.



Before



After

Key Features	Key Benefits
Not welded but cut from solid steel	<ul style="list-style-type: none"> Razor Mesh Panels will never have welds that fail Welded mesh is susceptible to rusting at the welded joints
Rigid	<ul style="list-style-type: none"> Capable of withstanding wind loads Panels can easily accommodate the weight of additional perimeter security appurtenances; including razor wire, cameras, sensor cables, etc
Anti-cut / Anti-climb properties	<ul style="list-style-type: none"> Small openings make it significantly more difficult to cut or climb Cutting requires special tools and intruder must cut a hole large enough to climb through
Easy Installation	<ul style="list-style-type: none"> No springing action during installation resulting in less field work Panels install more accurately without waste, dragging or overlapping Panels do not require special heavy equipment or machinery to install
Flexibility	<ul style="list-style-type: none"> Panels can be installed as standalone or easily integrated with any existing fence framework Panel design can be customized to your specific security needs
Visual deterrence	<ul style="list-style-type: none"> The increased height, intimidating appearance, and additional layer of security deters intruders from attempting to break into your site



What Goes Up **Doesn't Get Over**



When it comes to perimeter protection, Atkore Razor-Ribbon® barbed tape is trusted the world over. Manufactured in Hebron, OH and engineered to meet ASTM standards, Razor-Ribbon® is the cutting-edge security solution for any fence or framework from correctional facilities to chemical and nuclear sites to military and maritime applications. Make sure that the other side isn't an option.

Atkore Razor-Ribbon is a leading manufacturer of barbed tape products and a domestic manufacturer in the United States.

The Atkore Razor-Ribbon line of barbed tape products is the optimal choice for perimeter security protection. Manufactured for use in the most secure and restricted environments, Atkore Razor-Ribbon has enhanced security

protection for a variety of industrial, military, and institutional facilities.

Our Atkore Razor-Ribbon products are razor sharp and can create serious cuts on anyone trying to climb over the barrier. The products are not only used as a physical barrier but also work as a psychological deterrent. Atkore Razor-Ribbon is designed to deter, delay, and detect intruders.

What Sets Us Apart

- Nationwide and international distribution
- Superior deterrence and security
- Manufactured from exceptionally tough, high-quality stainless steel components with full traceability
- Single or double coil spiral or concertina available
- Various diameter and deployed lengths available
- Large capacity with quick turnaround
- Product workmanship warranty
- Easy-to-install
- Unparalleled customer and technical support

Barbed Tape Styles

Short Barb



Medium Barb



BTC NATO Barb



Long Barb



Instabarrier® Barb



Detainer Hook® Barb



Different Forms of Barbed Tape	6
Product Selector Guide.....	7
Enhanced Security Solutions	8
Razpr-Ribbon® Razor Mesh Panels	9-11
Installation Accessories	12-13
Rapid Deployment Units	14
RDU Magazines	15
Rapid Deployment Unit Trailers	16
Instabox Portable Rapid Deployment Unit.....	17
Razor-Ribbon Razor Cage	18
Razor-Ribbon Razor Cage Applications	19
Safety and Security Bollards.....	20
Base Plate Bollards and Decorative Covers	21
Safety and Security Bollard Solutions.....	22-23
Crash Rated Security Bollards	24-25
Crash Test Certified to F3016-19 Bollards.....	26
Why Atkore Razor-Ribbon	27

Razor Strand™

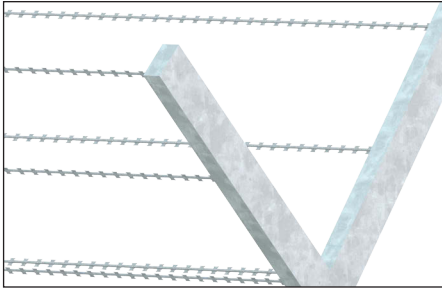

- Wire-reinforced alternative to traditional barbed wire for low-level security applications when added psychological deterrence is desired
- Can be installed in either lineal strands per barbed wire specifications or coils may be ordered as a substitute
- Available in any barb style
- Barbed tape and core available in stainless steel or galvanized
- Razor Strand comes in a standard length of 351' (107m)

Coreless

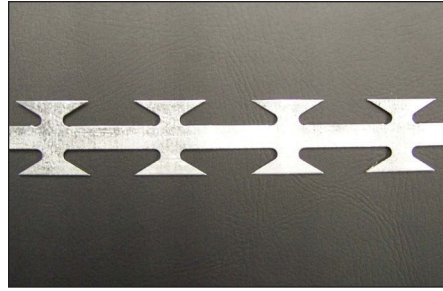

- Non-reinforced barbed tape
- Can be installed either in lineal strands or wrapped around objects to prevent climbing
- Available in any barb style in stainless steel or galvanized
- Coreless Barbed Tape comes in standard lengths of 1000' and 1500' (305m and 457m)

Helical



- Wire-reinforced helical barrier formed without clipping (slinky)
- Ideal product for low security applications
- Available in any barb style
- Barbed tape and core available in stainless steel or galvanized
- Helical coils come standard in diameters of 18", 24", 30", 36" (450mm, 600mm, 750mm, 900mm)

Concertina

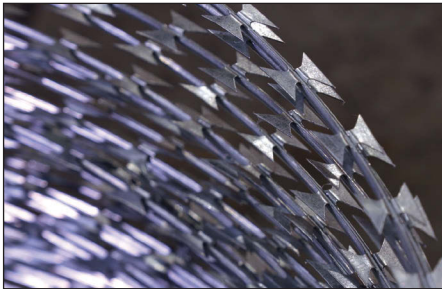

- Minimum to maximum perimeter security applications
- Single coil wire-reinforced concertina additionally formed utilizing steel clips
- "Tunnel" with restricted spaces between tape
- More clips = tighter spacing = higher security
- Available in any barb style
- Concertina barbed tape and core available in galvanized or stainless steel
- Various standard diameter, coil lengths and clip configurations available

Flat Razor Wrap



- Psychological deterrence
- Installs flat providing an aesthetically pleasing perimeter security delay barrier
- Easily replaceable in case of damage
- Multiple rows of Flat Razor Wrap can be added for greater security
- Powder coated coils available for added corrosion protection
- Flat Razor Wrap coils come standard in diameters of 18", 24", 30" (450mm, 600mm, 750mm)

Rapid Deployment



- Safe and easy installation
 - Less handling of material
 - Deploys quick and easy using ancillary equipment or truck
 - Posts/pickets not required
- Significantly less time and labor to install
 - Stacked coils are preconnected
 - Installation requires only 2-3 people
 - Can install up to 480' (146m) in minutes (Triple Strand), 246' (75m) for (Six Pack)
- Versatile
 - Can be used as temporary or permanent barrier
 - Reusable

Security Level	Product Name	Diameter		Loops	Clips	Loop Spacing		Length Per Roll		Weight Per Roll	
		(in)	(mm)			(in)	(mm)	(ft)	(m)	(lb)	(kg)
Commercial, Industrial, Military (Any Level)	BTC Barbed Tape <small>Short or Medium Barb Medium available offset</small>	18	450	56	3	16	406	37	11	17	8
		28	720	56	3	21	533	50	15	26	12
		36	900	50	5	24	600	50	15	30	14
		38	965	56	5	21	533	50	15	35	16
		40	1000	56	5	21	533	50	15	37	17
Commercial, Industrial, Military (Any Level)	BTC NATO-22 Barbed Tape <small>BTC NATO Barb Available offset</small>	18	450	56	3	16	406	36	11	17	8
		24	600	56	3	16	406	36	11	23	10
		28	720	56	3(5)	21(16)	533(406)	50(36)	15(11)	27	12
		30	750	56	5	21	533	50	15	28	13
		36	900	56	5	21	533	50	15	34	16
		38	980	56	5(7)	21(6)	533(150)	50(14)	15(4.3)	36	16
Warehousing, Construction, Manufacturing, Parking Lots (Low Level)	Razor-Ribbon® Helical <small>Long Barb (Standard) Short, Medium, BTC NATO-22 or Detainer Hook available Long, Medium and BTC NATO-22 available offset</small>	18	450	33	-	18	450	50	15	14	6
		24	600	33	-	18	450	50	15	18	8
		30	750	33	-	18	450	50	15	23	10
		36	900	33	-	18	450	50	15	28	12
Confinement, Detention, Utilities, Airports, Data Centers (Minimum to Maximum)	Maze® <small>Long Barb Available offset</small>	18	450	31	3	12	300	15	4.5	13	6
		24	600	31	3	16	400	20	6	18	8
		30	750	31	3	16	400	20	6	22	10
		36	900	31	3	16	400	20	6	26	12
		18/24	450/600	31/31	3	12	300	15	4.5	31	14
		24/30	600/750	31/31	3	16	400	20	6	39	18
Confinement, Detention, Utilities, Airports, Data Centers (Maximum)	Supermaze® <small>Long Barb Available offset</small>	30	750	51(81)	5	12	300	25(40)	7.5(12)	36(58)	16(26)
		36	900	51(81)	5	12	300	25(40)	7.5(12)	43(69)	20(31)
		40	1000	51(81)	5	12	300	25(40)	7.5(12)	48(77)	22(35)
	NATO Barrier™ <small>Long Barb Available offset</small>	40	1000	51(81)	7	12	300	25(40)	7.5(12)	49(77)	22(35)
		60	1500	51(101)	9	12	300	25(50)	7.5(15)	73(144)	33(65)
		19	483	31	3	12	300	15	4.5	15	7
Confinement, Detention, Nuclear, Petroleum/ Chemical Storage (Maximum)	Detainer Hook® Barb <small>Detainer Hook Barb</small>	25	635	31	3	16	400	20	6	20	9
		31	787	31(51)	3(5)	16(12)	400(300)	20(25)	6(7.5)	26(42)	12(19)
		37	940	51	5	12	300	25	7.5	51	23
		41	1041	51	7	12	300	25	7.5	57	26
		61	1549	81(101)	9	12	300	40(50)	12(15)	135(168)	61(76)
Ground Barrier for Confinement, Detention, Nuclear, etc. (Minimum to Maximum)	InstabARRIER® (Non-Reinforced) <small>InstabARRIER Barb</small>	24	600	101	3 welds	12	300	50	15	49	22
		30	750	101	5 welds	12	300	50	15	62	28
		40	1000	101	7 welds	12	300	50	15	82	37
		60	1500	101	13 welds	12	300	50	15	124	56
Commercial, Industrial, Utilities (Any level)	Flat Razor Wrap <small>Medium Barb (Standard) Short, NATO-22 available</small>	18	450	133	-	9	225	50	15	22	10
		24	600	100	-	12	300	50	15	22	10
		30	750	80	-	15	375	50	15	22	10

Barb Options



Short Barb



Medium Barb



BTC NATO Barb



Long Barb



InstabARRIER® Barb



Detainer Hook® Barb

Enhanced Security Solutions

Deter, Delay, Protect



Razor Mesh Panel

Atkore Razor-Ribbon's new Razor Mesh Panel is the FIRST line of defense to secure a perimeter, from medium to high, to ultra-high security fencing.

- Expanded metal panel with strands of Atkore Razor-Ribbon® secured on the panel
- Can be attached to any fence framework for added protection
- Imposing physical deterrent designed to keep you safe
- Anti-climb properties with small openings filled with razors
- Available in galvanized or stainless steel
- Corrosion-resistant
- 72% open with razors
- Easy installation - installs more accurately without waste, dragging, or overlapping
- Can be installed new or as a retro-fit over current chain link fence or chain link fence framework
- Fittings are some of the strongest in the industry and can be locked with breakaway nuts and bolts for added security

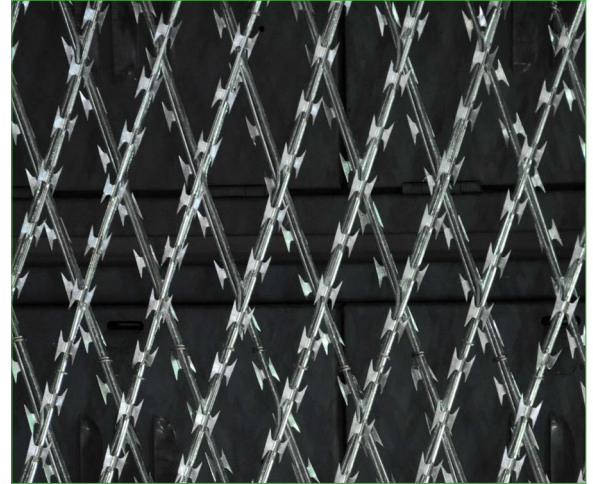

Size Offerings

- Panel width: 4 ft (122cm), or 5 ft (152cm)
- Panel height: 6 ft (183 cm), 8 ft (244 cm), 10 ft (305 cm), or 12 ft (366 cm)
- Diamond size: 2" x 6" (51mm x 152mm) with options of 3" x 6" (76mm x 152mm), and 1" x 2" (25mm x 51mm)

Uses: airport, utilities, refineries, nuclear, energy, etc.

SS-40 Fence Framework

SS-40 is manufactured with cold-formed steel which provides high yield and tensile strength, followed by a uniform triple layer of corrosion protection. The coating consists of zinc, a conversion coating, and a clear organic top coat applied in-line by the patented continuous Flo-Coat® process from Allied Tube & Conduit®.

Bending Strength Comparison SS 40 vs Schedule 40

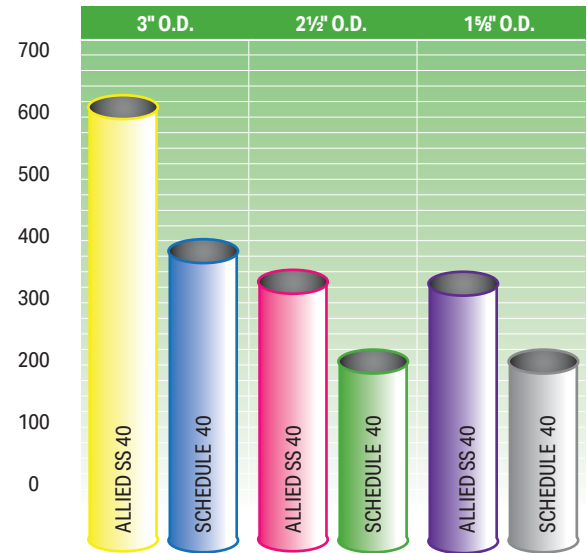

Test results are based on 6 foot cantilevered beam test and 10 foot free-supported beam test.

SS-40 Pipe Sizes

Fence Industry	Decimal O.D. Equivalent		Pipe Wall Thickness		Weight		Selection Modulus	Min. Yield Strength	Max Bending Moment	Calculated Load		
	(in)	(mm)	(in)	(mm)	(lb/ft)	(kg/m)				10' Free Supported	Cantilever	
O.D.	(in)	(mm)	(in)	(mm)	(lb/ft)	(kg/m)	(in ³)	(psi)	(lb/in)	(lb)	4'	6'
1 3/4	1.315	33.40	.104	2.64	1.35	2.01	.1111	x 50,000	= 5555	185	116	77
1 3/8	1.660	42.16	.111	2.82	1.84	2.74	.1961	x 50,000	= 9805	327	204	136
2	1.900	48.26	.120	3.05	2.28	3.39	.2810	x 50,000	= 14050	468	293	195
2 1/2	2.375	60.33	.130	3.30	3.12	4.64	.4881	x 50,000	= 24405	814	508	339
3	2.875	73.03	.160	4.06	4.64	6.90	.8778	x 50,000	= 43890	1463	914	610
3 1/2	3.500	88.90	.160	4.06	5.71	8.50	1.3408	x 50,000	= 67040	2235	1397	931
4	4.000	101.60	.160	4.06	6.56	9.76	1.7819	x 50,000	= 89095	2970	1856	1237

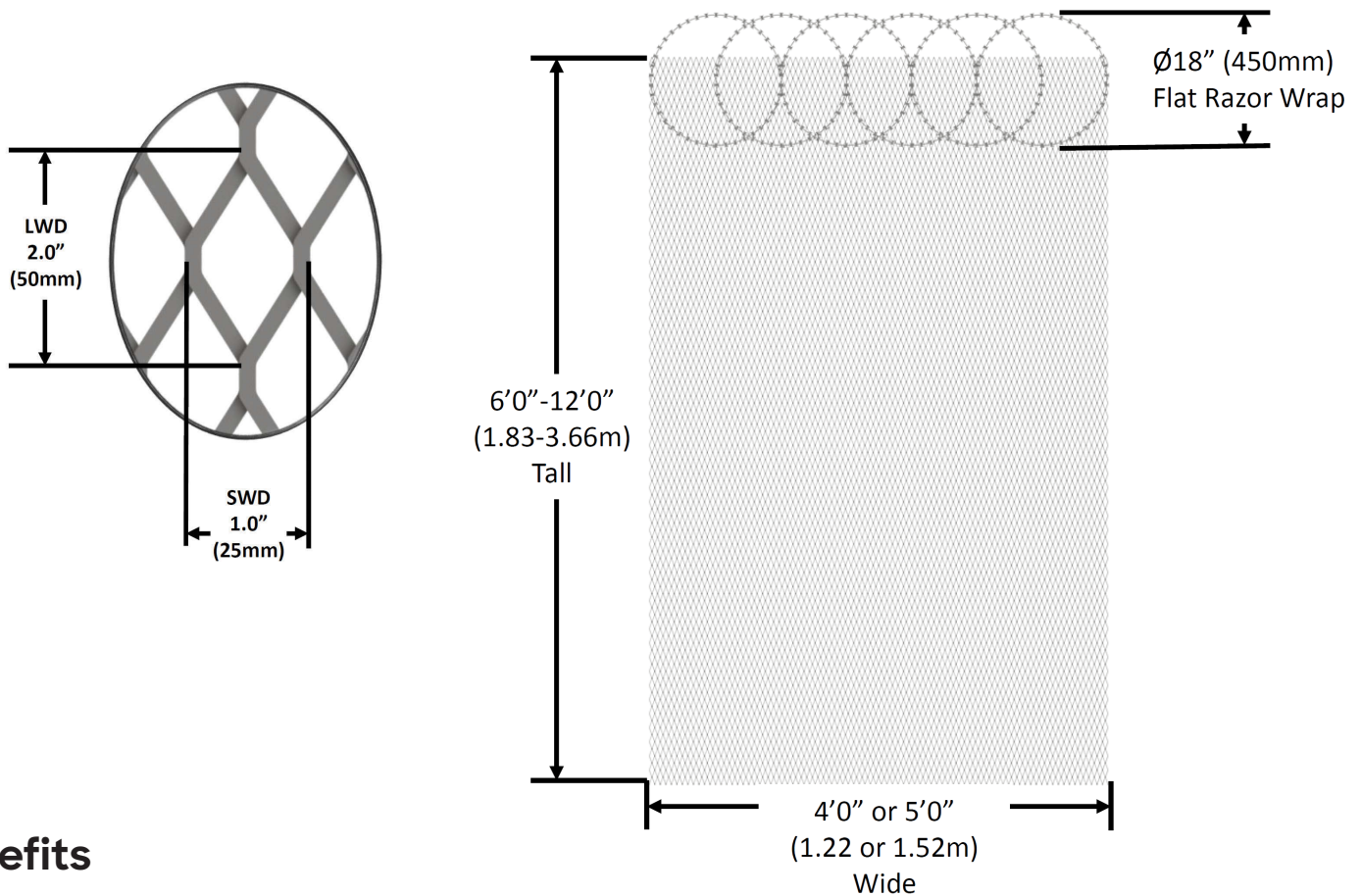

Benefits

- Anti-cut / anti-climb panels are easy to install (labor savings)
- Individual panels can be replaced if damaged, no need to replace large sections
- Domestic manufactured offering provides quick turnaround and on-time delivery per project schedule
- Flexibility of customizing panel sizes to fit all types of gates
- Panels provided with Atkore Razor-Ribbon pre-assembled
- No barb arms or barbed wire required providing installation and material savings as well as a stronger deterrence



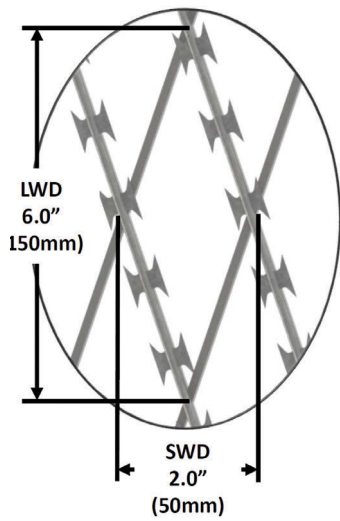

Razor strands
attached on
one side or
both sides

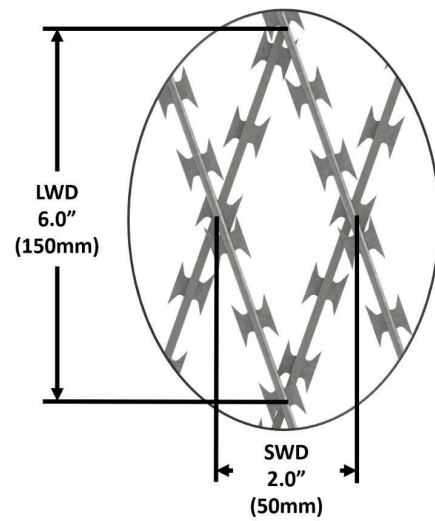

6'0"-12'0"
(1.83-3.66m)
Wide

4'0" or 5'0"
(1.22 or 1.52m)
Tall

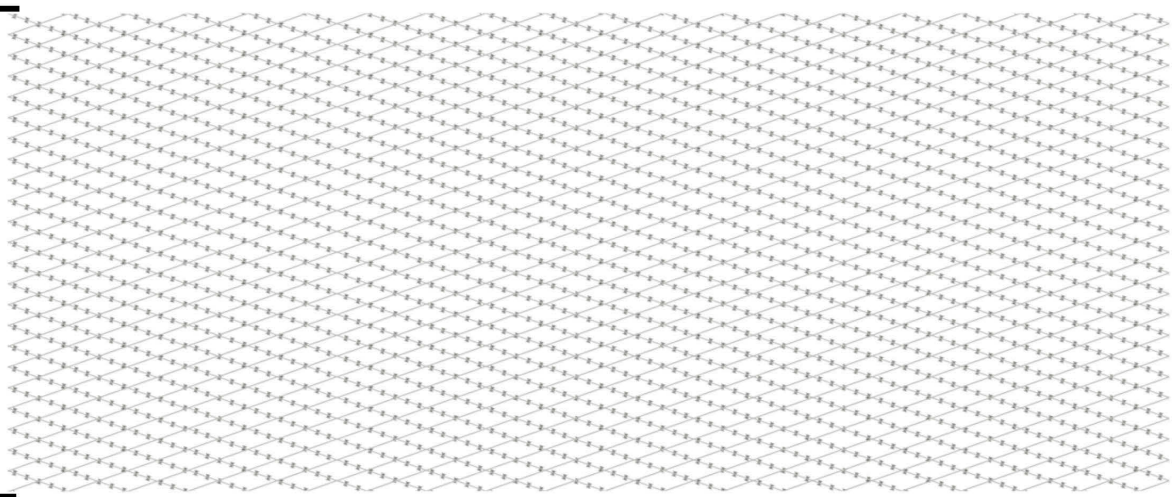

Hexarmor Gloves

These gloves were designed specifically for handling barbed tape products. These gloves are cut, puncture, and abrasion resistant.



Wire Tie Twist Tool

Used to twist wire ties in fence anchored installations.

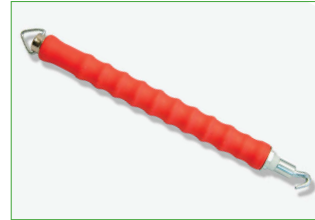

Hog Rings

For fence anchored installations, Hog Rings are used to connect the barbed tape to the fence fabric. Available loose and in clips.



Arm/Sleeve Guard

Used to protect the installer, the arm/sleeve guard covers from the wrist to the shoulder.



Ground Stakes

Required to anchor ground based installations, usually positioned at 10 foot intervals.



Warning Signs

Used to alert unsuspecting persons of imminent danger.



Retro-Fit Bar Clamps

Used to connect overlapping mesh.



Hog Ring Pliers

Used to compress hog rings in fence anchored installations.



Retro-Fit C-Clamp

Used to connect mesh to line posts and rails.



Retro-Fit Band

Used to connect mesh to terminal posts. Available in various sizes for different post diameters 1" x 11ga HDG.



Wire Ties

Used to secure and anchor installations.



Carriage Bolts and Breakaway Nuts

Used with Retro-Fit clamps and bands.



Rapid Deployment Units

Set, Deploy, And Secure In Seconds!



Features

- Economical, simple, and reusable rapid deployment system
- Capacity to deploy up to 480' (146m) of Triple Strand Atkore Razor-Ribbon in just minutes. 247' (75m) capacity for Six Pack
- Coils are preconnected eliminating the need for a large crew working hours in the field and the potential hazards that go with it
- Magazines come loaded with a stack of 3 or 6 coils that create a 6'-7' (1.8m-2.1m) tall by 5'-7.5' (1.5m-2.3m) wide barrier of Atkore Razor-Ribbon barbed tape
- Coils can be loaded back onto the magazine and ready for redeployment in under 20 minutes
- Various coil diameters and barb options available upon request

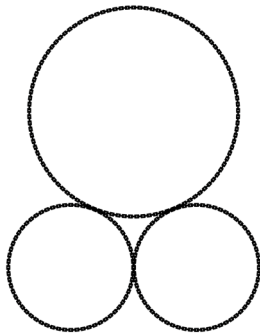

Triple Strand



Triple Strand RDU w/ Magazine

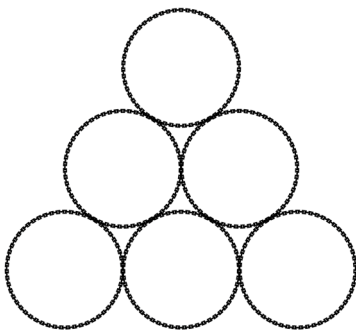

Six Pack



Six Pack RDU w/ Magazine

Rapid Deployment Unit Trailers

BTC Express Trailer

Features

- Patented design
- Versatile and economical rapid deployment system
- Designed for use in difficult terrains where forklifts can't be used to deploy a Triple-Strand Rapid Deployment Unit
- Compatible with any vehicle equipped with a standard hitch
- Trailer dimensions - 12.5' (3.8m) L x 7.3' (2.2m) W x 7' (2.1m) H approx.
- Trailer features - 4,000lb (1800kg) capacity, 6' (1.8m) long forks (fixed or adjustable), 5' (1.5m) width capacity, Hydraulic controls, Powder coat finish (customizable)
- Razor barrier dimensions - 500' (150m) L x 4.6' (1.4m) W x 6' (1.8m) H
- Triple-Strand Razor Wire Barrier (customizable)
- Made in USA. Complies with Buy America Act

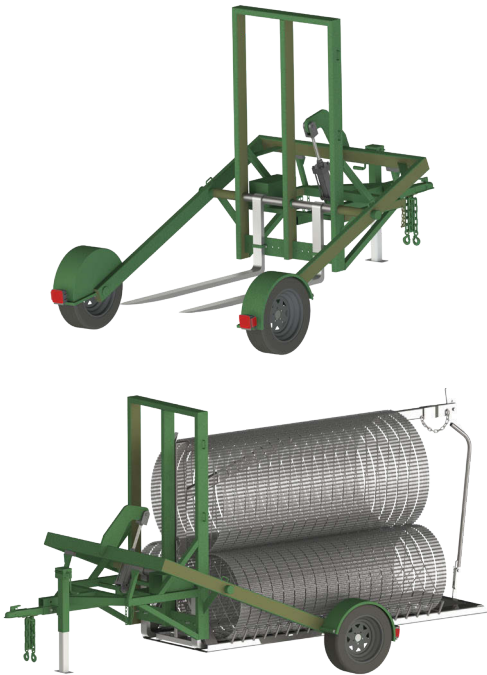

Rapid Deployment Unit (RDU) Covered Trailer

Features

- Patented design
- 3-pack RDU barrier housed in a covered trailer capable of deploying up to 500' (150m) in 30 seconds
- Reusable barrier - Coils can be loaded back onto the trailer and ready for redeployment in under 10 minutes
- RDU can be deployed as a temporary or permanent barrier for emerging threats
- Available in various lengths, barb styles, and configurations in stainless steel or galvanized steel
- RDU can be custom designed to fit customer's security needs
- Approved and used by the U.S. Department of Defense and other government agencies
- Made in USA. Complies with Buy America Act



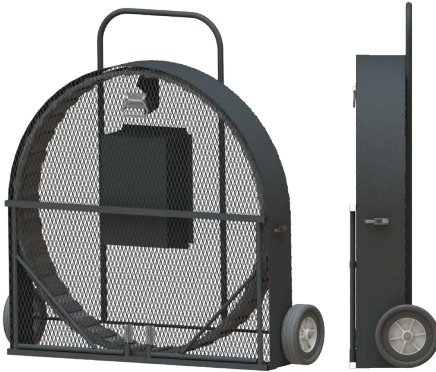

Features

- Patent pending design provides rapid barrier for controlled, limited and exclusion areas
- Appropriate as a temporary or permanent barrier for emerging threats
- Deploys up to 75 feet (22.8m) of barbless tape or non-reinforced InstabARRIER® barbed tape in under 30 seconds
- Deploys and retracts quickly and efficiently for reuse by a single person
- Removes the potentially hazardous conditions associated with field installation of coils
- Rugged design features heavy duty wheels, hot-dip galvanized panels and powder coat finish make the unit suitable for deployment in differing climates and terrain
- Lightweight, high strength and modular allowing multiple units to be easily tied together forming one continuous barrier
- Made in USA. Complies with Buy America Act

Instabox with Barbless Coil

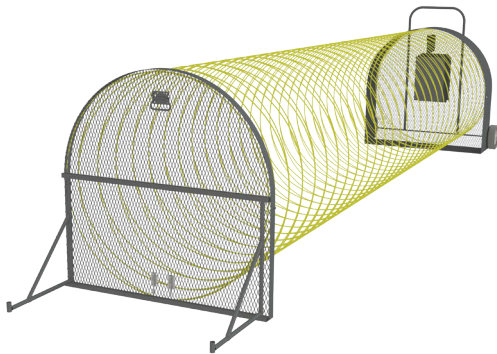

Instabox with InstabARRIER® Coil

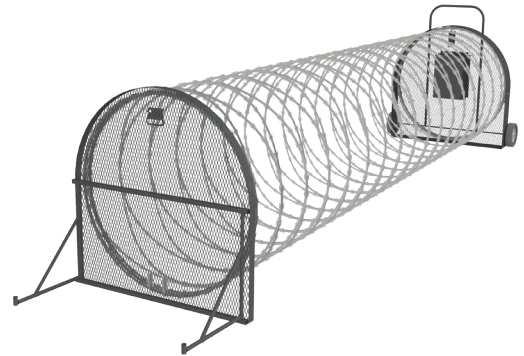

Diameter		Coil Loops	Clips	Loop Spacing		Yield	
(in)	(mm)			(in)	(mm)	(ft)	(m)
30	762	71	3	16	406	47	14
48	1219	71	5	12	305	35	11
48	1219	101	5	12	305	50	15
60	1524	71	7	12	305	35	11

Diameter		Coil Loops	Strip Material	Cable	Welds	Yield	
(in)	(mm)					(ft)	(m)
30	762	101	SS	1	5	50	15
30	762	151	SS	1	5	75	23
48	1219	151	SS	1	9	75	23
60	1524	101	SS	1	13	50	15

Barbless coils available powder coated for added visibility

Razor Cage

- High-quality steel structure lined with Razor Mesh Panels for added security
- Cages can be used to store high value assets or house a pyramid of concertina coils
- Cages also available with a rapid deployment unit inside for expanded barrier protection

Uses: power plants, prisons, jails, above ground, below ground, and other customers with high-security application requirements



Atkore Razor-Ribbon Razor Cage Applications

Razor Cage with swinging door for asset storage

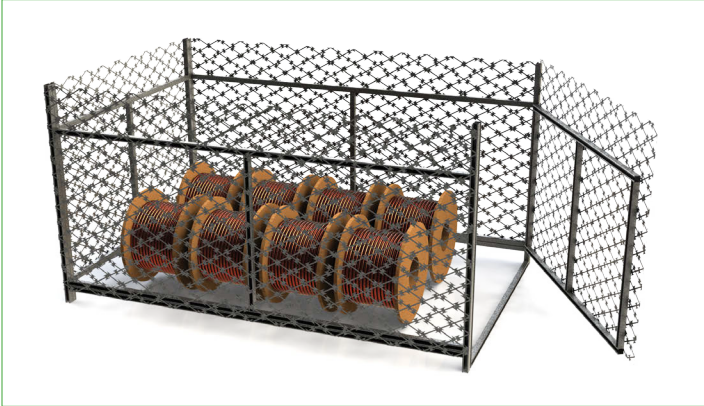

Razor Cage with fold down door for asset storage

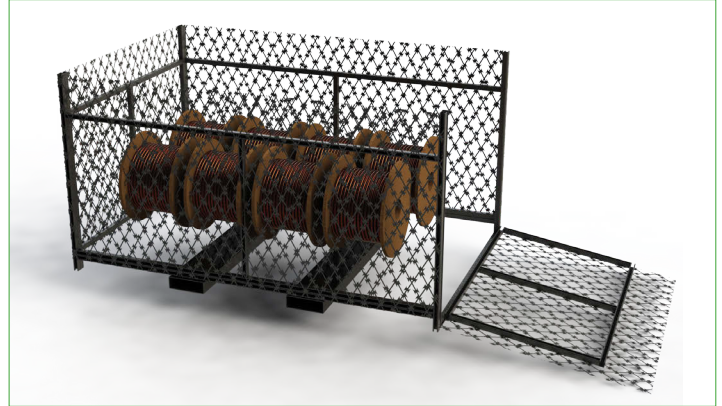

Razor Cage perimeter around assets

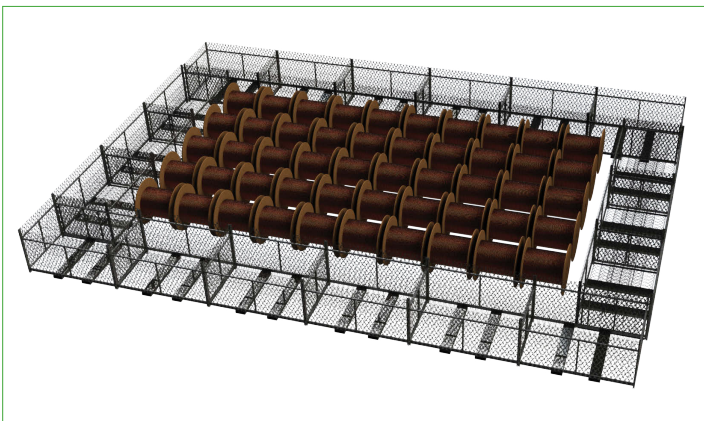

Razor Cage with Triple Strand Rapid Deployment Unit for gate and expanded barrier protection



Features

- Patented design protects a perimeter or an open space and restricts unauthorized vehicle access
- Available in hot-dip galvanized or stainless steel
- Easily moved and installed with a forklift
- Cage dimensions - 16' (4.9m) L x 6' (1.8m) W x 6' (1.8m) H (customizable)
- Specified as a permanent or temporary barrier
- Custom designed based on your security needs
- Ideal for utility or power plant applications
- Made in USA. Complies with Buy America Act

Safety and Security Bollards



Integrating a rated bollard into your perimeter security project gives the assurance the bollard will do what it was tested to do. Our rated products fall under our Perimeter Defense Technology line of bollards.



Calpipe Security is proud to offer an industrial line of surface mounted base plate bollards manufactured from the highest quality ASTM A53 carbon steel or 300 series stainless steel. Base plate bollards come in a variety of diameters and offer a quick and easy bolt-down installation providing an affixed physical barrier as well as a vehicle deterrence.

Combined with Calpipe Security's Heritage line of cast iron decorative covers, designers and planners are equipped with a broad range of base plate bollard choices that provide a traditional look to any project whether it's temporary or permanent. The Heritage line offers both flexibility and aesthetics to safety and security projects where style and profile options have been limited.

Base Plate Bollards

Stainless Steel			Carbon Steel		
Item #	Nominal Pipe Size		Item #	Nominal Pipe Size	
	(in)	(sch)		(in)	(sch)
SSB03040	3	40	IBB03040	3	40
SSB04040	4	40	IBB04040	4	40
SSB05040	5	40	IBB05040	5	40
SSB06040	6	40	IBB06040	6	40
SSB08040	8	40	IBB08040	8	40

Various Cover Options Available



Available Materials

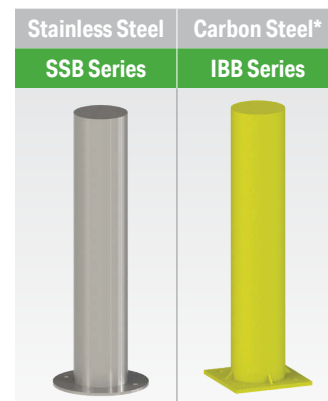

*Carbon steel bollards available with Grey Zinc Rich Primer coating or a variety of power coated options including safety yellow and jet black.

Safety and Security Bollard Solutions

Lighted

Architectural Lighted Bollards provide an aesthetic appeal while illuminating the surrounding landscape within a secure perimeter. Anchored to a baseplate foundation, these bollards are easy to install in any location.

- Stainless steel
- Light duty security lighted bollards
- Medium/Heavy security lighted bollards



Fixed

Permanently embedded bollards create a physical barrier for pedestrians and buildings from oncoming vehicles.

- Light security – parking lots, entrances, retail storefronts
- Medium security – hospitals, malls, stadiums
- High security – government facilities, power plants, chemical plants



Removable

External padlocking removable bollards provide a removable perimeter defense. Allows easy access for service and police vehicles into restricted areas.

- Type 316 stainless steel versions for harsher environments
- Parking lots, fire lanes, access roads, and driveways,
- Colleges, oil refineries, municipalities



Automatic Retractable

Designed for repetitive cycles, these bollards are ideal for high-level traffic control parking lots, access control gates, commercial building entrances, and military bases. These bollards can

- Stainless steel composition to avoid corrosion
- Operate with most existing access control systems
- Key system, guard operated, proximity card



Shallow Mount

These bollards use a shallow 12" (300mm) embedment to provide the highest level of protection found around corporate campuses, government buildings, airports, power and water plants.

- Can stop a 15,000-pound (7.5 tons) vehicle at a speed of 50 miles per hour (80.46 km per hour)
- K12/M50-rated
- Significant savings over deep mount bollard installations



Crash Rated

ASTM F3016 crash-rated bollards protect people and property that are vulnerable to low-speed vehicular impact.

- K4/M30- and K12/M50-rated options
- Fixed and removable versions
- Airports, manufacturing plants, railways, gas stations, transportation terminals



Crash Rated Security Bollards

Calpipe Security Bollards®

Calpipe Security Bollards® is a worldwide leader in manufacturing high security bollards and is a part of Atkore. Their high security K/M-rated and ASTM crash-tested bollards have been installed to protect patrons and property from accidents and vehicle attacks at pedestrian plazas, professional sports stadiums, various embassies, border crossings facilities, and military sites.



What Level of Protection Are You Looking For?

Vehicle Weight		Vehicle Speed	DOS/DOD Rating	ASTM Rating
(lb)	(t)	(mph)		
15,000	7.5	50 MPH	K12	M50
15,000	7.5	30 MPH	K4	M30

Perimeter Defense Technology Bollards:

Calpipe Security Bollards Mfg. Model #	Description	Speed Rating/ Penetration Rating	As Tested Requirement	Certifying/ Testing Agency & Test Specification
PDTDS22	Fixed Bollard-Deep Mount 10" Diameter 39" Above Grade 44" Embedded Depth	K12 / L3	Minimum Bollard Array: (2) Center on Center Spacing: 59"	DOS DOD DOS: SD-STD-02.01 Rev. A
PDTDS22R	Removable Bollard-Deep Mount 10" Diameter 39" Above Grade 44" Embedded Depth	K12 / L3	Minimum Bollard Array: (2) Center on Center Spacing: 59"	DOS DOD DOS: SD-STD-02.01 Rev. A
PDTDS22L	Deep Mount Lighted Bollard 10" Diameter 50" (FLAT CAP) 44" Embedded Depth	K12 *Engineered	Minimum Bollard Array: (2) Center on Center Spacing: 59"	DOS
PDT10080SMF	Fixed Bollard-Shallow Mount 10" Diameter 36" Above Grade 12" Embedded Depth	M50 / P2	Minimum Bollard Array: (3) Center on Center Spacing: 60"	ASTM ASTM: International Designation F2656-07
PDT10080SMR	Removable Bollard-Shallow Mount 10" Diameter 36" Above Grade 12" Embedded Depth	M50 *Engineered	Minimum Bollard Array: (3) Center on Center Spacing: 60"	ASTM ASTM: International Designation F2656-07
PDT10080SML	Shallow Mount Lighted Bollard 10" Diameter 45 3/8" (FLAT CAP) 12" Embedded Depth	M50 *Engineered	Minimum Bollard Array: (3) Center on Center Spacing: 60"	ASTM ASTM: International Designation F2656-07
PDT1200P	Pneumatic/Automatic Retractable Bollard 10" Diameter 36" Deployed Height 58" Embedded Depth	K12 / L3 PAS68:2010	Minimum Bollard Array: (3) Center on Center Spacing: 39" Single Bollard Test-PAS68	DOS - DOD BSI: V/7500(N3)/80/90:7.1/0.0 DOS: SD-STD-02.01 Rev. A
PDT1200H	Hydraulic/Automatic Retractable Bollard 10" Diameter 36" Deployed Height 58" Embedded Depth	K12 / L3 PAS68:2010	Minimum Bollard Array: (3) Center on Center Spacing: 39" Single Bollard Test-PAS68	DOS - DOD BSI: V/7500(N3)/80/90:7.1/0.0 DOS: SD-STD-02.01 Rev. A
PDT1200M	Assisted Lift - Manual Retractable 10" Diameter 36" Deployed Height 58" Embedded Depth	K12 / L3 PAS68:2010	Minimum Bollard Array: (3) Center on Center Spacing: 39" Single Bollard Test-PAS68	DOS - DOD BSI: V/7500(N3)/80/90:7.1/0.0 DOS: SD-STD-02.01 Rev. A
PDT1200A	Screw Driven - Manual Retractable 10" Diameter 36" Deployed Height 58" Embedded Depth	K12 / L3 PAS68:2010	Minimum Bollard Array: (3) Center on Center Spacing: 39" Single Bollard Test-PAS68	DOS - DOD BSI: V/7500(N3)/80/90:7.1/0.0 DOS: SD-STD-02.01 Rev. A

Perimeter Defense Technology Bollards (Continued):

Calpipe Security Bollards Mfg. Model #	Description	Speed Rating/ Penetration Rating	As Tested Requirement	Certifying/ Testing Agency & Test Specification
PDT8080F	Fixed Bollard-Deep Mount 8" Diameter 36" Above Grade 36" Embedded Depth	M30 *Engineered	Minimum Bollard Array: (2) Center on Center Spacing: 48"	ASTM ASTM: International Designation F2656-07
PDT8080R	Removable Bollard-Deep Mount 8" Diameter 36" Above Grade 36" Embedded Depth	M30 *Engineered	Minimum Bollard Array: (2) Center on Center Spacing: 48"	ASTM ASTM: International Designation F2656-07
PDT8080L	Deep Mount Lighted Bollard 8" Diameter 45 7/8" Above Grade 36" Embedded Depth	M30 *Engineered	Minimum Bollard Array: (2) Center on Center Spacing: 48"	ASTM ASTM: International Designation F2656-07
PDT8080SMF	Fixed Bollard-Shallow Mount 8" Diameter 36" Above Grade 12" Embedded Depth	M30 / P2	Minimum Bollard Array: (3) Center on Center Spacing: 48"	ASTM ASTM: International Designation F2656-07
PDT8080SMR	Removable Bollard-Shallow Mount 8" Diameter 36" Above Grade 12" Embedded Depth	M30 / P2	Minimum Bollard Array: (3) Center on Center Spacing: 48"	ASTM ASTM: International Designation F2656-07
PDT8080SML	Shallow Mount Lighted Bollard 8" Diameter 45 7/8" Above Grade 12" Embedded Depth	M30 *Engineered	Minimum Bollard Array: (3) Center on Center Spacing: 48"	ASTM ASTM: International Designation F2656-07
PDT06080CF-S10	Fixed Bollard 6" Diameter 36" Above Grade / 24" Below Grade 32" Foundation Depth	S10 / P1	Single Bollard Test	ASTM ASTM: International Designation F3016-19
PDT06080CR-S10	Removable Bollard 6" Diameter 36" Above Grade / 24" Below Grade 32" Foundation Depth	S10 / P1	Single Bollard Test	ASTM ASTM: International Designation F3016-19
PDT06080CF-S20	Fixed Bollard 6" Diameter 36" Above Grade / 24" Below Grade 32" Foundation Depth	S20 / P2	Single Bollard Test	ASTM ASTM: International Designation F3016-19
PDT06080CR-S20	Removable Bollard 6" Diameter 36" Above Grade / 24" Below Grade 32" Foundation Depth	S20 / P2	Single Bollard Test	ASTM ASTM: International Designation F3016-19

DOS standard SD-STD-02.01 Rev. A dated 2003: The rating of a barrier is determined when a 15,000 lb. vehicle impacts a barrier from a perpendicular direction. Barriers listed on the retired DOS Certified Anti-Ram Vehicle Barriers list are considered also to be DOD Certified. The current DOD Anti-Ram Vehicle Barrier list supersedes all previous copies. The following ratings apply under this standard for vehicle impact speed ("K") and penetration distance resulting in the vehicle being arrested ("L"). ("K") indicates the DOS certified barrier speed ratings' maximum vehicle impact speed achieved when a vehicle traveling at a nominal speed is successfully arrested by the barrier from a perpendicular direction:

- K4 = 30 mph, K8 = 40 mph, K12 = 50 mph
- L3 = 3 ft. or less, L2 = 3 ft. to 20 ft., L1 = 20 ft. to 50 ft.

ASTM International Designation F2656-07 is a test method providing a structured procedure to establish a penetration rating for perimeter barriers subject to a perpendicular 15,000 lb. vehicle impact. The following ratings apply under this method for impact speed ("M") and penetration distance resulting in the vehicle being arrested ("P"):

- M30 = 30 mph, M40 = 40 mph, M50 = 50 mph
- P1 = 3.3 ft. or less, P2 = 3.3 ft. to 23 ft., P3 23.1 ft. to 98.4 ft., P4 = 98 ft. or greater

ASTM International Designation F3016-19 is a Standard Test Method for Surrogate Testing (5,000 lbs.) of Vehicle Impact Protective Devices at Low Speeds. The following ratings apply under this method for impact speed ("S") and penetration distance resulting in the vehicle being arrested ("P"):

- S10 = 10 mph, S20 = 20 mph, S30 = 30 mph
- P1 = 1 ft. or less, P2 = 1 ft. to 4 ft., Failure = Greater than 4 ft.
- The barrier penetration rating does not imply that a barrier will perform as rated in all site conditions, approach routes, and topography

PAS 68 is the British Standards Institution's ("BSI") specification for vehicle security barriers. It identifies the impact test methods, tolerances, test vehicle type, and vehicle performance criteria to be met and is considered to be the UK Standard.

* Engineered - No crash testing performed; speed rating assigned per technical specifications; penetration rating undetermined



Calpipe Security proudly introduces our new line of F3016-19 crash rated security bollards designed to mitigate the risk of vehicle-into-building impact.

Tested and certified to the American Society for Testing Material's F3016-19 standard. The ASTM F3016-19 standard quantifies the performance of a vehicle protective device in stopping a 5,000 lb. (2.5 ton) vehicle at impact speeds from 10 to 30 mph (16 to 48 kph).

Utilizing a short pile foundation design provides more versatility for the bollard's application whether it's a new installation or retrofit project. Common applications include commercial storefronts, outdoor dining, sidewalks, bus stops, and similar environments.



Features and Benefits:

- Certified to the ASTM F3016-19 standard as a single bollard
- Fixed and removable bollard options provide versatility for any application
- Core drilled installation is both cost and time effective - up to 75% cheaper than trench footings
- Customizable with a powder coated or stainless-steel finish for an aesthetic design

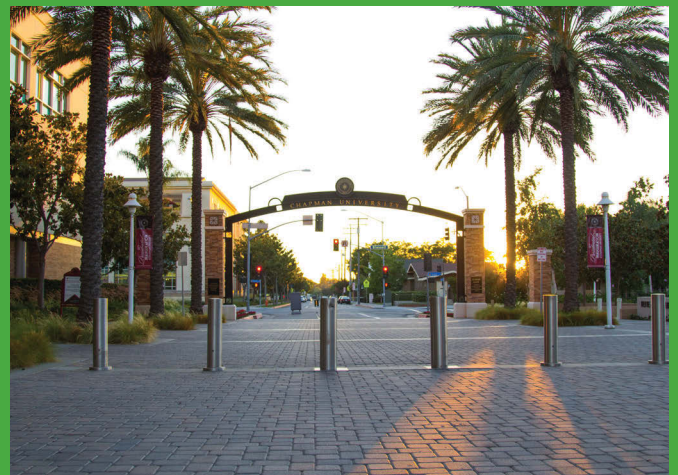

Over 40 Years Proven Industry Experience Manufacturing Barbed Tape and Providing Security Solutions

- Manufactured in the USA
- Original Barbed Tape Design Patent Holder
- Conforms to All Federal, State and Industrial Specifications
- Manufactured from 100% Traceable Materials
- Meets 100% of ASTM Standards
- Buy American / America Act Certified
- Manufacturer's Warranty
- Nationwide Distribution from Manufacturing Facility in Hebron, Ohio
- Quick Turnaround, as quick as One Week Delivery
- Easy-to-Install
- Rigid, Retains Shape Post Installation
- Has Offset Barb for Superior Deterrence & Security
- Stainless Steel & Zinc Coated Clips Eliminate Slippage
- Available in Various Diameters & Deployment Lengths
- Wire Ties & Hog Rings Provided with All Orders

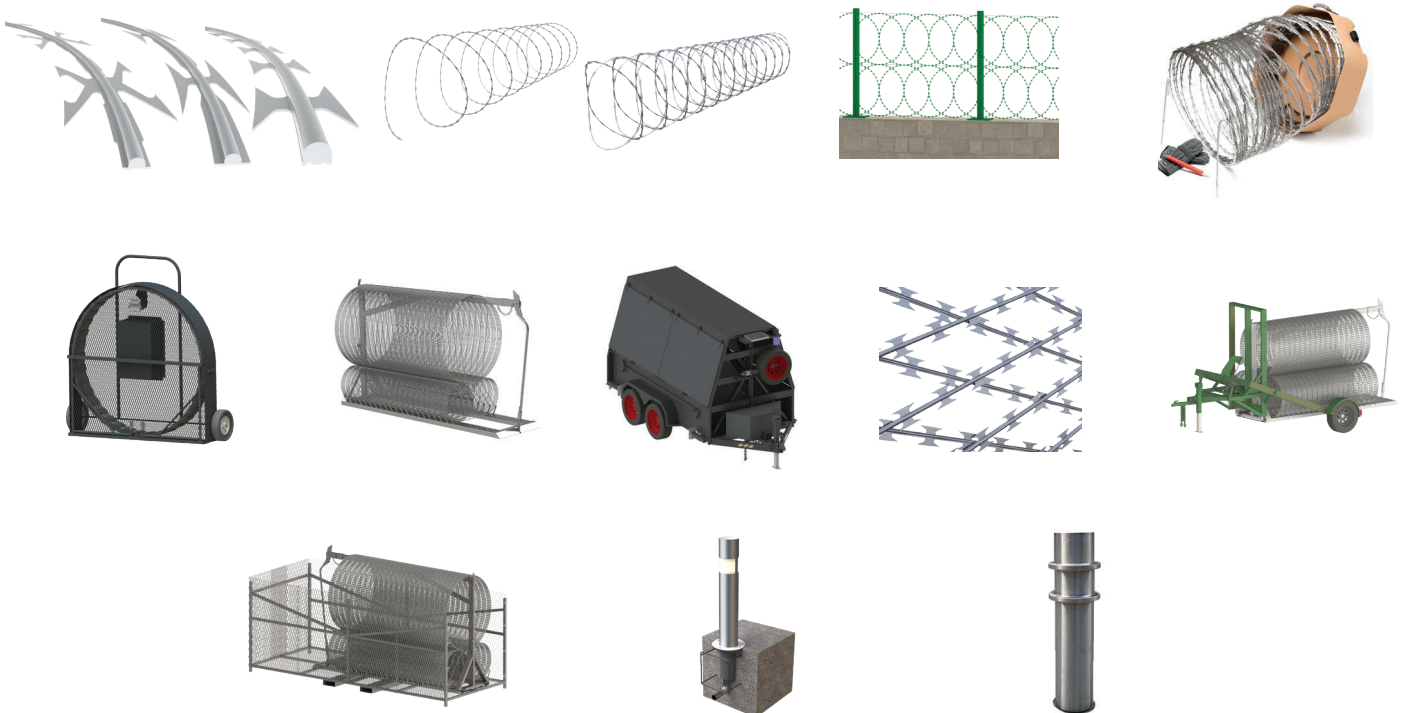



Allied Tube & Conduit ▲ AFC Cable Systems ▲ Heritage Plastics ▲ Unistrut
Unistrut Construction ▲ United Poly Systems ▲ Calbrite ▲ Calbond ▲ Cii ▲ US Tray
Power-Strut ▲ Calconduit ▲ Razor Ribbon ▲ Calpipe Security ▲ Vergokan ▲ Marco
Columbia-MBF ▲ Eastern Wire + Conduit ▲ ACS/Uni-Fab ▲ Sasco Strut ▲ Kaf-Tech
Cope ▲ FRE Composites ▲ Queen City Plastics ▲ Four Star Industries ▲ Flexicon

Atkore

16100 South Lathrop Avenue
Harvey, IL 60426

PHONE / 740-928-1019

TOLL FREE / 877-285-4066

atkore.com/razorribbon

Want to join a company that helps you build
the mindset, skill set and tool set for success?
Visit us at atkore.com/careers